

Plastic Encapsulated Series

Lead Frame Molded Photodiodes

OSI Optoelectronics offers a line of high quality and reliability plastic encapsulated photodiodes. These molded devices are available in a variety of shapes and sizes of photodetectors and packages, including industry standard T1 and T13/4, flat and lensed side lookers as well as a surface mount version (SOT- 23). They are excellent for mounting on PCB and hand held devices in harsh environments.

They have an **excellent response** in the **NIR spectrum** and are also available with visible blocking compounds, transmitting only in the 700-1100 nm range. They offer fast switching time, low capacitance as well as low dark current. They can be utilized in both photoconductive and photovoltaic modes of operation.

APPLICATIONS

- Bar Code Readers
- Industrial Counters
- Measurement and Control
- IR Remote Control
- Reflective Switches

FEATURES

- High Density Package
- Rugged Molded Package
- Low Capacitance
- Low Dark Current
- Lead Frame Standard
- SMT
- Molded Lens Feature
- Side Lookers
- Filter on Chip (700nm Cutoff)

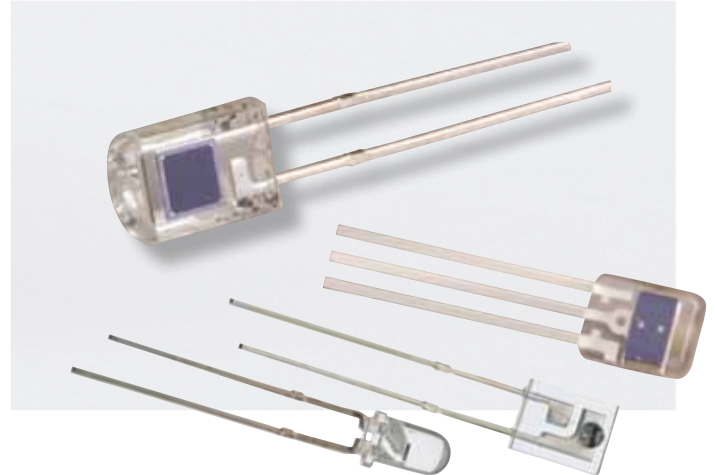

Distributor

info@amstechnologies.com
www.amstechnologies-webshop.com

Contact us

Typical Angular Detection Characteristics

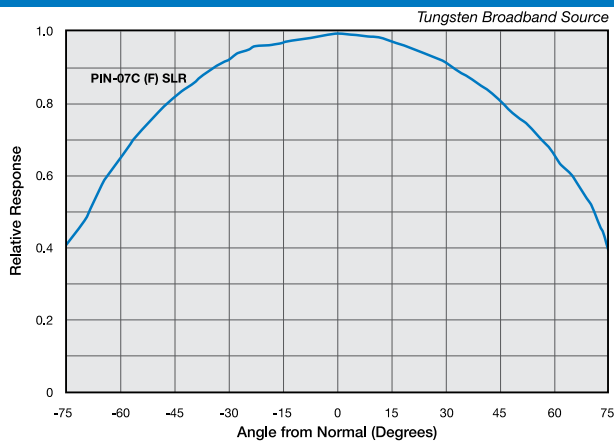

Typical Capacitance vs. Reverse Bias Voltage

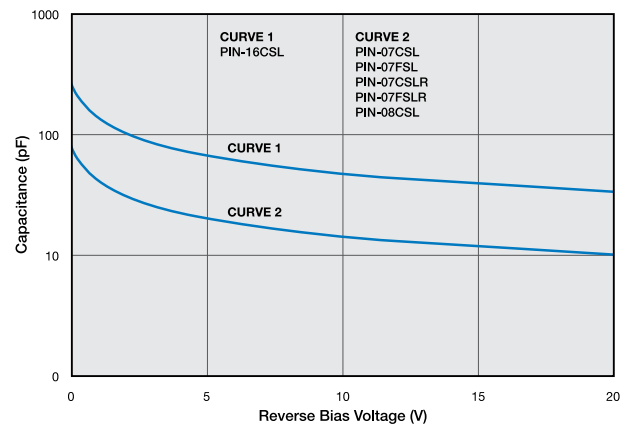

Typical Spectral Response

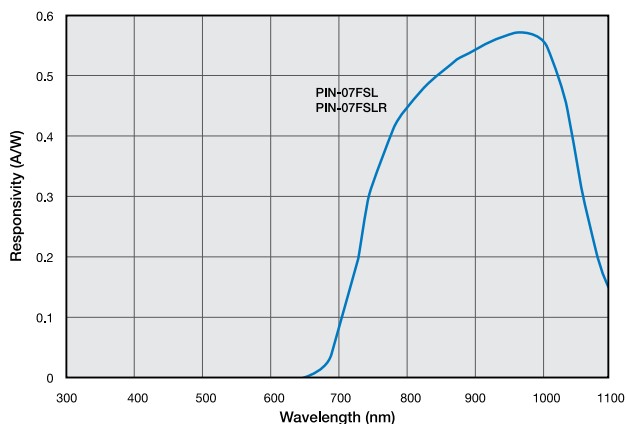

Typical Spectral Response

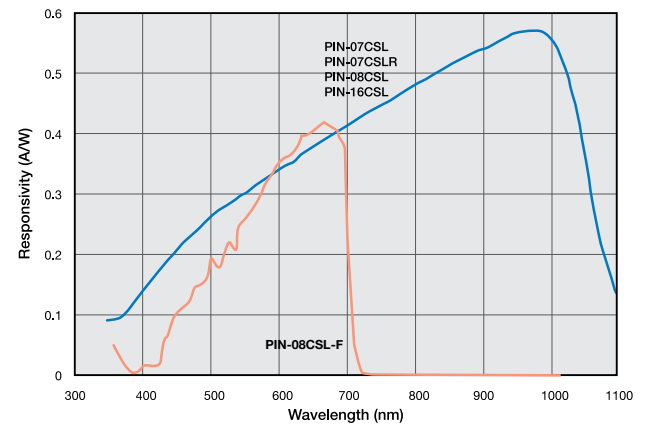

Plastic Encapsulated Series «

Typical Electro-Optical Specifications at T_A=23°C

Model Number	Active Area		Spectral Range (nm)	Responsivity I _p =970nm	Capacitance (pF) 1 MHz		Dark Current (nA)		Reverse Voltage (V)	Rise Time (ns)	Temp.* Range (°C)		Package Style ¶							
	Area (mm ²)	Dimensions (mm)		(A/W)	0 V	-10 V	-10 V			-10 V peak λ. 50 Ω	Operating	Storage								
				typ.	typ.	typ.	typ.	max.		max.				typ.						
PIN-0.81-LLS	0.81	1.02 φ	350-1100	0.55	10	2	2	30	20	11	-25 ~ +85	-40 ~ +100	62 / Leadless Ceramic							
PIN-0.81-CSL													60 / Resin Molded							
PIN-4.0-LLS	3.9	2.31x1.68	350-1100		60	10	5			5			50	62 / Leadless Ceramic						
PIN-4.0-CSL														60 / Resin Molded						
PIN-07-CSL	8.1	2.84 Sq	350-1100		85	15	5			5			50	57 / Resin Molded						
PIN-07-FSL			700-1100																	
PIN-07-CSLR			350-1100																	
PIN-07-FSLR	8.1	2.84 Sq	700-1100		0.55	100	25			10			30	75	56 / Resin Molded					
PIN-08-CSL-F	8.4	2.90 Sq	350-720												0.43@660nm	..	25	..	10	60 / Resin Molded
PIN-8.0-LLS	8.4	2.90 Sq	350-1100												100	25	10	5	30	50
PIN-8.0-CSL				60 / Resin Molded																
PIN-16-CSL	16	4.00 Sq			330	55	5		100		60 / Resin Molded									

¶ For mechanical drawings please refer to pages 61 thru 73.

* Non-Condensing temperature and Storage Range, Non-Condensing Environment.

The "CSL-F" series is a homogeneous silicon photodiode and optical filter combination device. The filter coating is directly deposited onto the chip during wafer process.

AVOID DIRECT LIGHT

Since the spectral response of silicon photodiode includes the visible light region, care must be taken to avoid photodiode exposure to high ambient light levels, particularly from tungsten sources or sunlight. During shipment from OSI Optoelectronics, your photodiodes are packaged in opaque, padded containers to avoid ambient light exposure and damage due to shock from dropping or jarring.

AVOID SHARP PHYSICAL SHOCK

Photodiodes can be rendered inoperable if dropped or sharply jarred. The wire bonds are delicate and can become separated from the photodiode's bonding pads when the detector is dropped or otherwise receives a sharp physical blow.

CLEAN WINDOWS WITH OPTICAL GRADE CLOTH / TISSUE

Most windows on OSI Optoelectronics photodiodes are either silicon or quartz. They should be cleaned with isopropyl alcohol and a soft (optical grade) pad.

OBSERVE STORAGE TEMPERATURES AND HUMIDITY LEVELS

Photodiode exposure to extreme high or low storage temperatures can affect the subsequent performance of a silicon photodiode. Storage temperature guidelines are presented in the photodiode performance specifications of this catalog. Please maintain a non-condensing environment for optimum performance and lifetime.

OBSERVE ELECTROSTATIC DISCHARGE (ESD) PRECAUTIONS

OSI Optoelectronics photodiodes, especially with IC devices (e.g. Photops) are considered ESD sensitive. The photodiodes are shipped in ESD protective packaging. When unpacking and using these products, anti-ESD precautions should be observed.

DO NOT EXPOSE PHOTODIODES TO HARSH CHEMICALS

Photodiode packages and/or operation may be impaired if exposed to CHLOROTHENE, THINNER, ACETONE, or TRICHLOROETHYLENE.

INSTALL WITH CARE

Most photodiodes in this catalog are provided with wire or pin leads for installation in circuit boards or sockets. Observe the soldering temperatures and conditions specified below:

Soldering Iron:	Soldering 30 W or less Temperature at tip of iron 300°C or lower.
Dip Soldering:	Bath Temperature: 260±5°C. Immersion Time: within 5 Sec. Soldering Time: within 3 Sec.
Vapor Phase Soldering:	DO NOT USE
Reflow Soldering:	DO NOT USE

Photodiodes in plastic packages should be given special care. Clear plastic packages are more sensitive to environmental stress than those of black plastic. Storing devices in high humidity can present problems when soldering. Since the rapid heating during soldering stresses the wire bonds and can cause wire to bonding pad separation, it is recommended that devices in plastic packages to be baked for 24 hours at 85°C.

The leads on the photodiode **SHOULD NOT BE FORMED**. If your application requires lead spacing modification, please contact OSI Optoelectronics Applications group at (310)978-0516 before forming a product's leads. Product warranties could be voided.



*Most of our standard catalog products are RoHS Compliant. Please contact us for details

Mechanical Drawings

Mechanical Specifications and Die Topography

1. Parameter Definitions:

A = Distance from top of chip to top of glass.

a = Photodiode Anode.

B = Distance from top of glass to bottom of case.

c = Photodiode Cathode

(Note: cathode is common to case in metal package products unless otherwise noted).

W = Window Diameter.

F.O.V. = Filed of View (see definition below).

2. Dimensions are in inches (1 inch = 25.4 mm).

3. Pin diameters are 0.018 ± 0.002 " unless otherwise specified.

4. Tolerances (unless otherwise noted)

General: $0.XX \pm 0.01$ "

$0.XXX \pm 0.005$ "

Chip Centering: ± 0.010 "

Dimension 'A': ± 0.015 "

5. Windows

All '**UV**' Enhanced products are provided with QUARTZ glass windows, 0.027 ± 0.002 " thick.

All '**XUV**' products are provided with removable windows.

All '**DLS**' PSD products are provided with A/R coated glass windows.

All '**FIL**' photoconductive and photovoltaic products are epoxy filled instead of glass windows.



$$F.O.V. = \tan^{-1} \left(\frac{W}{2A} \right)$$

For Further Assistance
Please Call One of Our Experienced
Sales and Applications Engineers

310-978-0516

OSI Optoelectronics
An OSI Systems Company

- Or -

visit our website at

www.osioptoelectronics.com

56 Lead Frame Molded

Products:
PIN-07SLR
PIN-07FSLR

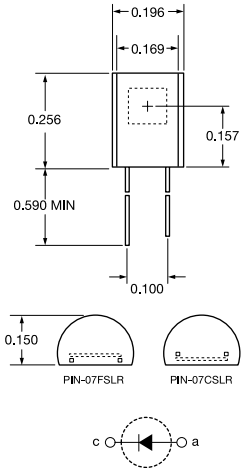

57 Lead Frame Molded

Products:
PIN-07CSL
PIN-07FSL

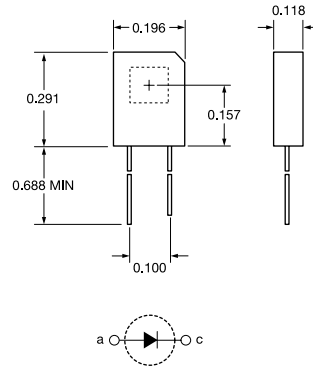

58 Ceramic LCC

Products:
PIN-4X4D

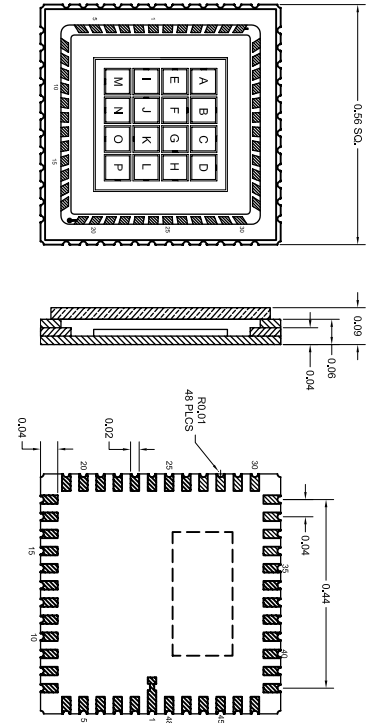

59 Ceramic LCC

Products:
UDT-4X4D

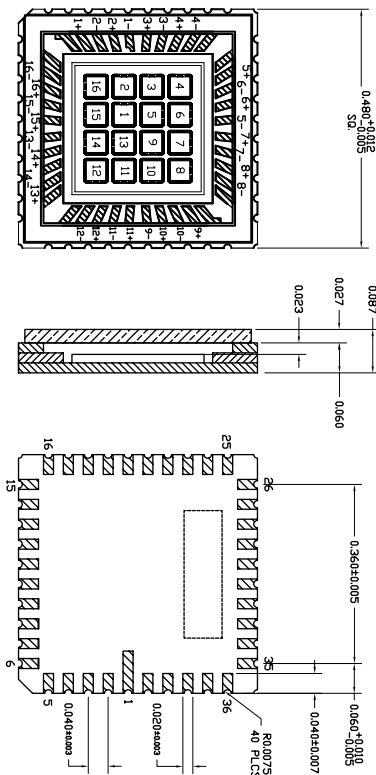

60 Lead Frame Molded

Products:
PIN-0.81-CSL
PIN-4.0-CSL
PIN-8.0-CSL
PIN-08-CSL
PIN-16-CSL
PIN-08-CSL-F

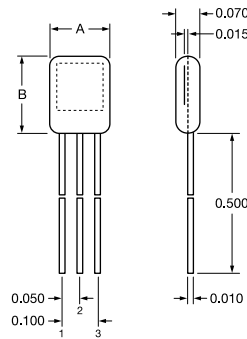

Dimensions		
P/N	A	B
PIN-16CSL	0.215	0.264
All Others	0.170	0.220

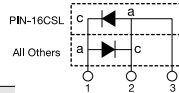

61 SMT

Products:
BI-SMT

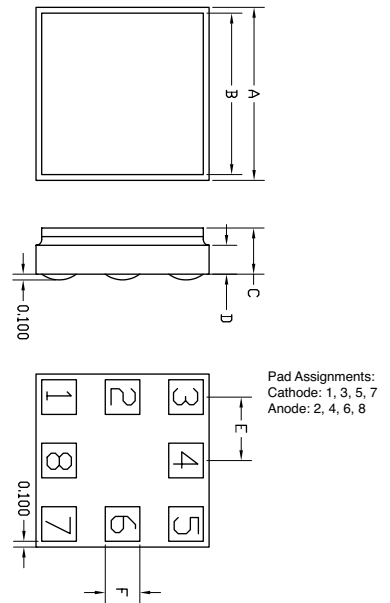

Pad Assignments:
Cathode: 1, 3, 5, 7
Anode: 2, 4, 6, 8

Dimensions in inches						
Model Number	A	B	C	D	E	F
33BI-SMT	0.118	0.11	0.031	0.02	0.043	0.024
55BI-SMT	0.197	0.189	0.051	0.039	0.071	0.024
1010BI-SMT	0.394	0.386	0.051	0.039	0.163	0.059

Mechanical Specifications

All units in inches.

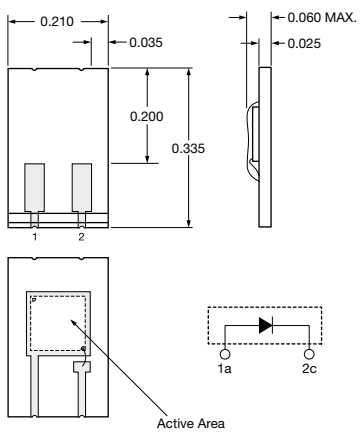
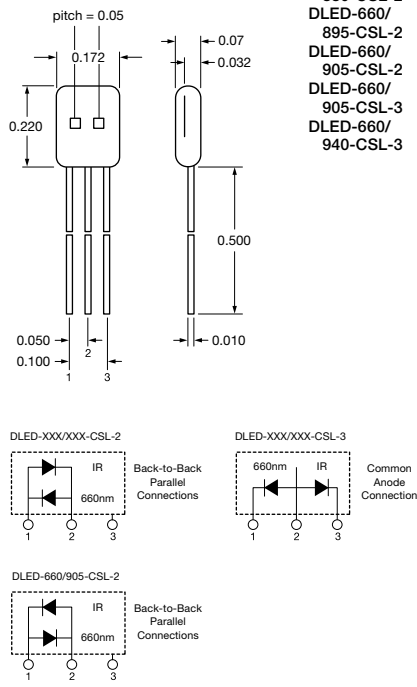
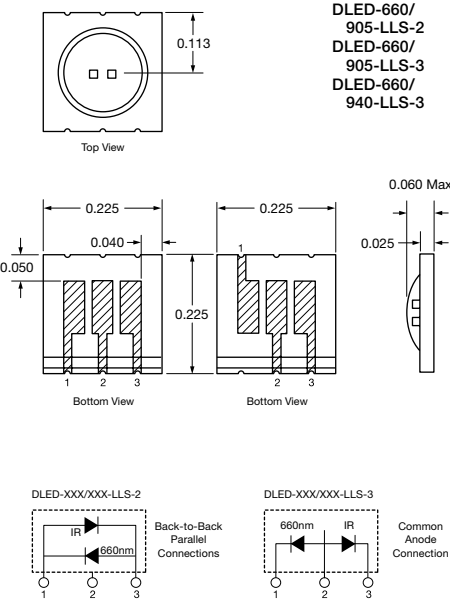
62 Leadless Ceramic	63 Lead Frame Molded	64 Leadless Ceramic
<p>Products: PIN-0.81-LLS PIN-4.0-LLS PIN-8.0-LLS</p> 	<p>Products: DLED-660/ 880-CSL-2 DLED-660/ 895-CSL-2 DLED-660/ 905-CSL-2 DLED-660/ 905-CSL-3 DLED-660/ 940-CSL-3</p> 	<p>Products: DLED-660/ 880-LLS-2 DLED-660/ 895-LLS-2 DLED-660/ 905-LLS-2 DLED-660/ 905-LLS-3 DLED-660/ 940-LLS-3</p> 

BPW-34

Plastic Molded - Industry Standard

BPW-34 series are a family of high quality and reliability plastic encapsulated photodiodes. The devices in this series, exhibit similar electrical characteristics, but vary in optical response. BPW-34B has an excellent response in the blue region of the spectrum. **They are excellent for mounting on PCB and hand held devices in harsh environments.**

APPLICATIONS

- IR Sensors
- Bar Code Scanners
- Color Analysis
- Smoke Detectors

FEATURES

- High Reliability
- High Density Package
- Rugged Resin Mold
- High Speed and Low Dark Current



Model Number	Active Area		Peak Responsivity Wavelength	Responsivity at λ_p			Capacitance (pF)		Dark Current (nA)		NEP (W/ $\sqrt{\text{Hz}}$)	Reverse Voltage (V)	Rise Time (ns)	Temp* Range (°C)		Package Style †
	Area (mm ²)	Dimensions (mm)		λ_p (nm)	(A/W)		0 V	-10 V	-10 V					-10 V	Operating	
			typ.		min.	typ.	typ.	typ.	typ.	max.	typ.	max.	typ.			
BPW-34 «	7.25	2.69 sq.	970	0.55	0.60	65	12	2	30	4.2e-14	40	20	-25 ~ +85	-40 ~ +100	19 / Plastic Molded	
BPW-34S				0.15**	0.20**											1.3e-13**
BPW-34B «																

BPW 34 Series

BPW-34 «	7.25	2.69 sq.	970	0.55	0.60	65	12	2	30	4.2e-14	40	20	-25 ~ +85	-40 ~ +100	19 / Plastic Molded	
BPW-34S				0.15**	0.20**											1.3e-13**
BPW-34B «																

† For mechanical drawings please refer to pages 61 thru 73.

* Non-condensing temperature and storage range, Non-condensing environment.

** Responsivity and NEP values for the BPW-34B are given at 410nm.

« Minimum order quantities apply

Typical Dark Current vs. Temperature

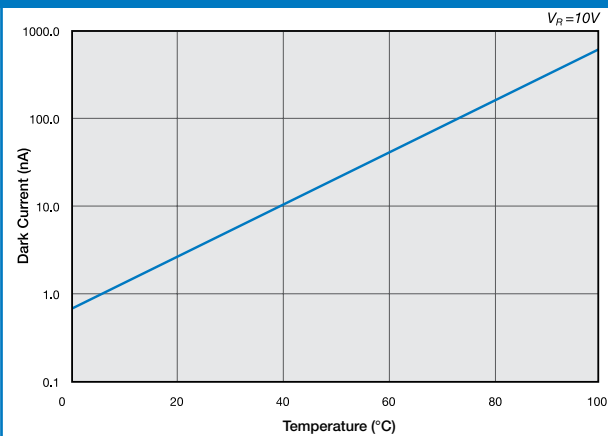

Typical Dark Current vs. Reverse Bias

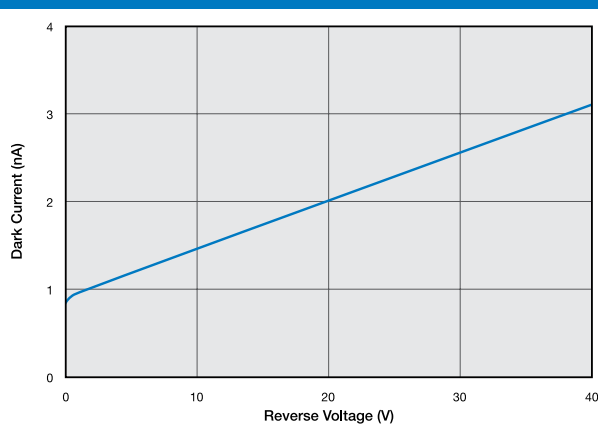

Typical Capacitance vs. Reverse Bias Voltage

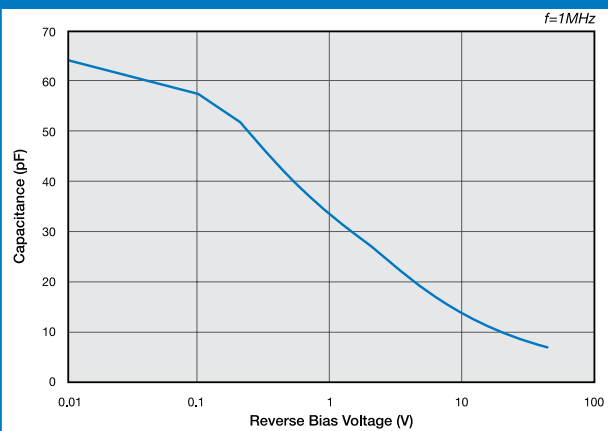

Typical Spectral Response

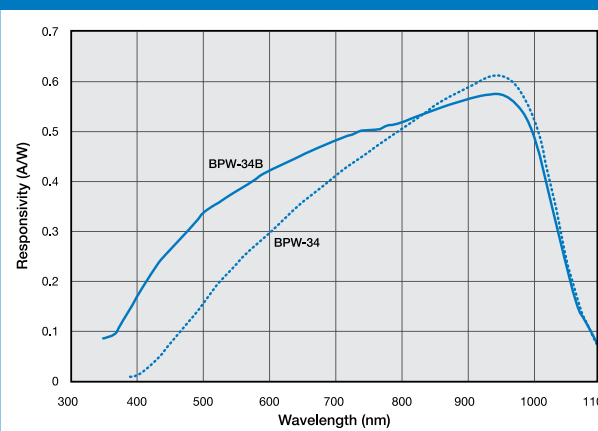

SMD (BPW34 S) IR Reflow Solder Profile (Lead-free)

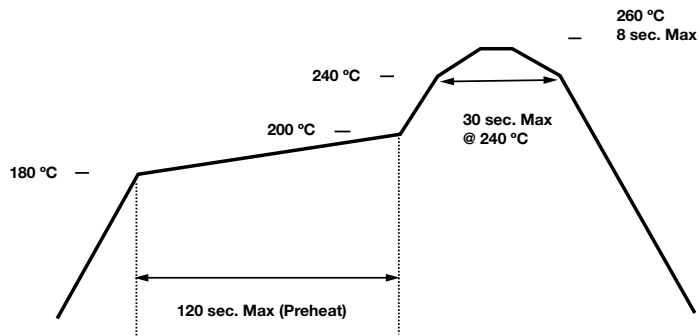

SMD Metal Plating: Silver

Pb Free Solder Paste: Sn96.5/Ag3.0/Cu0.5
Sn 97/Ag3.0

Manual Soldering (Lead-free)

Soldering Iron:
Soldering 30 W or less.
Temperature at tip of iron 300°C or lower.

AVOID DIRECT LIGHT

Since the spectral response of silicon photodiode includes the visible light region, care must be taken to avoid photodiode exposure to high ambient light levels, particularly from tungsten sources or sunlight. During shipment from OSI Optoelectronics, your photodiodes are packaged in opaque, padded containers to avoid ambient light exposure and damage due to shock from dropping or jarring.

AVOID SHARP PHYSICAL SHOCK

Photodiodes can be rendered inoperable if dropped or sharply jarred. The wire bonds are delicate and can become separated from the photodiode's bonding pads when the detector is dropped or otherwise receives a sharp physical blow.

CLEAN WINDOWS WITH OPTICAL GRADE CLOTH / TISSUE

Most windows on OSI Optoelectronics photodiodes are either silicon or quartz. They should be cleaned with isopropyl alcohol and a soft (optical grade) pad.

OBSERVE STORAGE TEMPERATURES AND HUMIDITY LEVELS

Photodiode exposure to extreme high or low storage temperatures can affect the subsequent performance of a silicon photodiode. Storage temperature guidelines are presented in the photodiode performance specifications of this catalog. Please maintain a non-condensing environment for optimum performance and lifetime.

OBSERVE ELECTROSTATIC DISCHARGE (ESD) PRECAUTIONS

OSI Optoelectronics photodiodes, especially with IC devices (e.g. Photops) are considered ESD sensitive. The photodiodes are shipped in ESD protective packaging. When unpacking and using these products, anti-ESD precautions should be observed.

DO NOT EXPOSE PHOTODIODES TO HARSH CHEMICALS

Photodiode packages and/or operation may be impaired if exposed to CHLOROTHENE, THINNER, ACETONE, or TRICHLOROETHYLENE.

INSTALL WITH CARE

Most photodiodes in this catalog are provided with wire or pin leads for installation in circuit boards or sockets. Observe the soldering temperatures and conditions specified below:

Soldering Iron:	Soldering 30 W or less Temperature at tip of iron 300°C or lower.
Dip Soldering:	Bath Temperature: 260±5°C. Immersion Time: within 5 Sec. Soldering Time: within 3 Sec.
Vapor Phase Soldering:	DO NOT USE
Reflow Soldering:	DO NOT USE

Photodiodes in plastic packages should be given special care. Clear plastic packages are more sensitive to environmental stress than those of black plastic. Storing devices in high humidity can present problems when soldering. Since the rapid heating during soldering stresses the wire bonds and can cause wire to bonding pad separation, it is recommended that devices in plastic packages to be baked for 24 hours at 85°C.

The leads on the photodiode **SHOULD NOT BE FORMED**. If your application requires lead spacing modification, please contact OSI Optoelectronics Applications group at (310)978-0516 before forming a product's leads. Product warranties could be voided.



*Most of our standard catalog products are RoHS Compliant. Please contact us for details

Mechanical Drawings

Mechanical Specifications and Die Topography

1. Parameter Definitions:

A = Distance from top of chip to top of glass.

a = Photodiode Anode.

B = Distance from top of glass to bottom of case.

c = Photodiode Cathode

(Note: cathode is common to case in metal package products unless otherwise noted).

W = Window Diameter.

F.O.V. = Filed of View (see definition below).

2. Dimensions are in inches (1 inch = 25.4 mm).

3. Pin diameters are 0.018 ± 0.002 " unless otherwise specified.

4. Tolerances (unless otherwise noted)

General: $0.XX \pm 0.01$ "

$0.XXX \pm 0.005$ "

Chip Centering: ± 0.010 "

Dimension 'A': ± 0.015 "

5. Windows

All '**UV**' Enhanced products are provided with QUARTZ glass windows, 0.027 ± 0.002 " thick.

All '**XUV**' products are provided with removable windows.

All '**DLS**' PSD products are provided with A/R coated glass windows.

All '**FIL**' photoconductive and photovoltaic products are epoxy filled instead of glass windows.

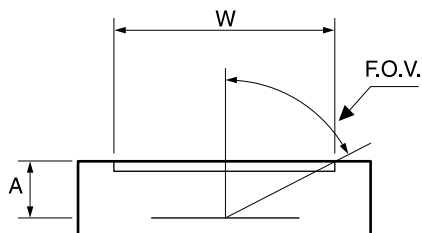

$$F.O.V. = \tan^{-1} \left(\frac{W}{2A} \right)$$

For Further Assistance
Please Call One of Our Experienced
Sales and Applications Engineers

310-978-0516

OSI Optoelectronics
An OSI Systems Company

- Or -

visit our website at

www.osioptoelectronics.com

Mechanical Specifications

All units in inches. Pinouts are bottom view.

16 TO-18 Lensed Cap 17 TO-5 18 TO-5

Products:
 PIN-HR005L
 PIN-HR008L
 PIN-HR020L
 PIN-HR026L
 PIN-HR040L

Pin Circle Dia.=0.100

1a 2c 3 Case

Products:
 PIN-DSS
 PIN-DSIn

Pin Circle Dia.=0.220

Bottom Diode Top Diode
 PIN-DSS

Bottom Diode Top Diode
 PIN-DSIn

Products:
 PIN-005D-245F

Pin Circle Dia.=0.215

2c 1a

19 Plastic Mold 20 Special Metal 21 Special Metal

Products:
 BPW34
 BPW34B
 BPW34S

Tab Identifies Cathode (c)

(c) a

BPW34S

CATHODE

Products:
 SPOT-15-YAG
 SPOT-9-YAG
 PIN-100-YAG

GR=Guard Ring

Pin Circle Dia.=0.750

Pinouts

P/N	1	2	3	4	5	6
SPOT-15-YAG	C1	GR	C4	C2	A	C3
SPOT-9-YAG	C1	GR	C4	C2	A	C3
PIN-100-YAG	--	C	--	--	A	--

Products:
 SC-50D

Pin Circle Dia.=1.110