

Soft X-Ray, Deep UV Enhanced Series

Inversion Layer Silicon Photodiodes

OSI Optoelectronics' 1990 R&D 100 award winning X-UV detector series are a unique class of silicon photodiodes designed for additional sensitivity in the X-Ray region of the electromagnetic spectrum without use of any scintillator crystals or screens. Over a wide range of sensitivity from 200 nm to 0.07 nm (6 eV to 17,600 eV), one electron-hole pair is created per 3.63eV of incident energy which corresponds to extremely high stable quantum efficiencies predicted by $E(\text{ph}) / 3.63\text{eV}$ (See graph below). For measurement of radiation energies above 17.6 keV, refer to the "Fully Depleted High Speed and High Energy Radiation Detectors" section.

A reverse bias can be applied to reduce the capacitance and increase speed of response. In the unbiased mode, these detectors can be used for applications requiring low noise and low drift. These detectors are also excellent choices for detecting light wavelengths between 350 to 1100 nm.

The detectors can be coupled to a charge sensitive preamplifier or low-noise op-amp as shown in the circuit on the opposite page.

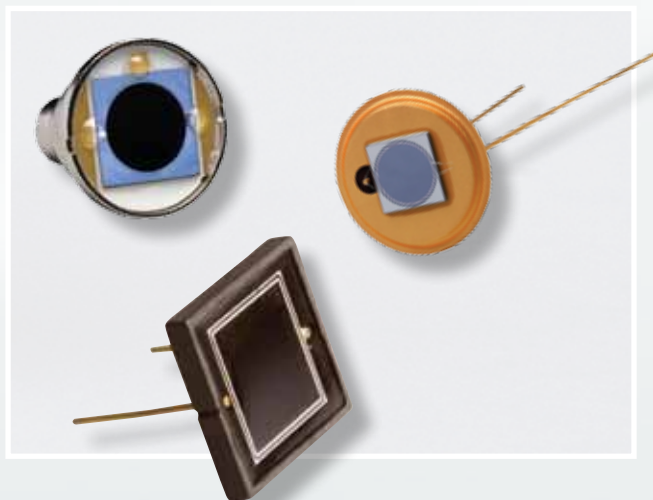

APPLICATIONS

- Electron Detection
- Medical Instrumentation
- Dosimetry
- Radiation Monitoring
- X-ray Spectroscopy
- Charged Particle Detection

FEATURES

- Direct Detection
- No Bias Needed
- High Quantum Efficiency
- Low Noise
- High Vacuum Compatible
- Cryogenically Compatible
- 0.070 nm to 1100 nm Wavelength Range

Typical Quantum Efficiency

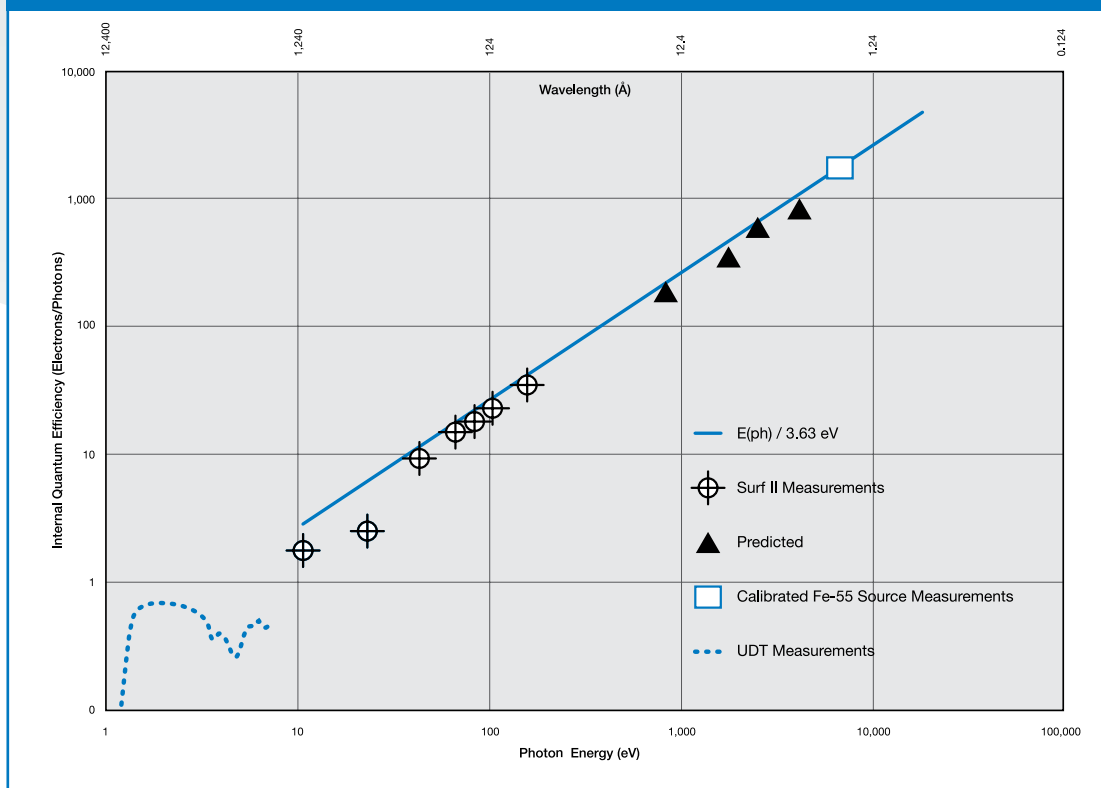

Soft X-Ray, Deep UV Enhanced Photodiodes

Typical Electro-Optical Specifications at $T_A=23^{\circ}\text{C}$

Model Number	Active Area		Capacitance (nF)		Shunt Resistance ($\text{M}\Omega$)		NEP ($\text{W}/\sqrt{\text{Hz}}$)		Temp. Range* ($^{\circ}\text{C}$)		Package Style [¶]
	Area (mm^2)	Dimension (mm)	0 V		-10 mV		0V 200 nm		Operating	Storage	
			typ.	max.	min.	typ.	typ.	max.			

'XUV' Series Metal Package

Model	Area	Dimension	Capacitance (0V) typ.	Capacitance (0V) max.	Shunt Resistance (-10mV) min.	Shunt Resistance (-10mV) typ.	NEP (0V, 200nm) typ.	NEP (0V, 200nm) max.	Operating Temp. Range	Storage Temp. Range	Package Style
XUV-005	5	2.57 ϕ	0.3	0.5	200	2000	2.9 e -15	9.1 e -15	-20 ~ +60	-20 ~ +80	22 / TO-5
XUV-020	20	5.00 ϕ	1.2	1.6	50	500	5.8 e -15	1.8 e -14			23 / TO-8
XUV-035	35	6.78 x 5.59	2	3	30	300	7.4 e -15	2.3 e -14			
XUV-100	100	11.33 ϕ	6	8	10	100	7.4 e -15	4.1 e -14			28 / BNC

'XUV' Series Ceramic Package

Model	Area	Dimension	Capacitance (0V) typ.	Capacitance (0V) max.	Shunt Resistance (-10mV) min.	Shunt Resistance (-10mV) typ.	NEP (0V, 200nm) typ.	NEP (0V, 200nm) max.	Operating Temp. Range	Storage Temp. Range	Package Style
XUV-50C	50	8.02 ϕ	2	3	20	200	9.1 e -15	2.9 e -14	-20 ~ +60	-20 ~ +80	25 / Ceramic
XUV-100C	100	10.00 sq	6	8	10	100	1.3 e -14	4.1 e -14			25 / Ceramic

[¶] For mechanical drawings please refer to pages 61 thru 73.
 All XUV devices are supplied with removable windows.
 * Non-Condensing temperature and Storage Range, Non-Condensing Environment.

Circuit example

In this circuit example, the pre-amplifier is a FET input op-amp or a commercial charge sensitive preamplifier. They can be followed by one or more amplification stages, if necessary. The counting efficiency is directly proportional to the incident radiation power. The reverse bias voltage must be selected so that the best signal-to-noise ratio is achieved.

For low noise applications, all components should be enclosed in a metal box. Also, the bias supply should be either simple batteries or a very low ripple DC supply.

Amplifier: OPA-637, OPA-27 or similar
 R_F : 10 $\text{M}\Omega$ to 10 $\text{G}\Omega$
 R_S : 1 $\text{M}\Omega$; Smaller for High Counting Rates
 C_F : 1pF
 C_D : 1pF to 10 μF

OUTPUT $V_{\text{OUT}} = Q / C_F$
 Where Q is the Charge Created By One Photon or One Particle

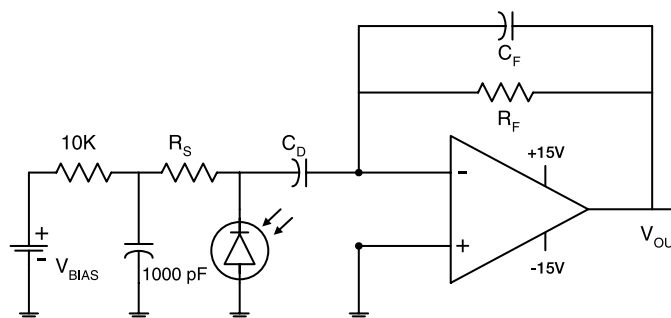

AVOID DIRECT LIGHT

Since the spectral response of silicon photodiode includes the visible light region, care must be taken to avoid photodiode exposure to high ambient light levels, particularly from tungsten sources or sunlight. During shipment from OSI Optoelectronics, your photodiodes are packaged in opaque, padded containers to avoid ambient light exposure and damage due to shock from dropping or jarring.

AVOID SHARP PHYSICAL SHOCK

Photodiodes can be rendered inoperable if dropped or sharply jarred. The wire bonds are delicate and can become separated from the photodiode's bonding pads when the detector is dropped or otherwise receives a sharp physical blow.

CLEAN WINDOWS WITH OPTICAL GRADE CLOTH / TISSUE

Most windows on OSI Optoelectronics photodiodes are either silicon or quartz. They should be cleaned with isopropyl alcohol and a soft (optical grade) pad.

OBSERVE STORAGE TEMPERATURES AND HUMIDITY LEVELS

Photodiode exposure to extreme high or low storage temperatures can affect the subsequent performance of a silicon photodiode. Storage temperature guidelines are presented in the photodiode performance specifications of this catalog. Please maintain a non-condensing environment for optimum performance and lifetime.

OBSERVE ELECTROSTATIC DISCHARGE (ESD) PRECAUTIONS

OSI Optoelectronics photodiodes, especially with IC devices (e.g. Photops) are considered ESD sensitive. The photodiodes are shipped in ESD protective packaging. When unpacking and using these products, anti-ESD precautions should be observed.

DO NOT EXPOSE PHOTODIODES TO HARSH CHEMICALS

Photodiode packages and/or operation may be impaired if exposed to CHLOROTHENE, THINNER, ACETONE, or TRICHLOROETHYLENE.

INSTALL WITH CARE

Most photodiodes in this catalog are provided with wire or pin leads for installation in circuit boards or sockets. Observe the soldering temperatures and conditions specified below:

Soldering Iron:	Soldering 30 W or less Temperature at tip of iron 300°C or lower.
Dip Soldering:	Bath Temperature: 260±5°C. Immersion Time: within 5 Sec. Soldering Time: within 3 Sec.
Vapor Phase Soldering:	DO NOT USE
Reflow Soldering:	DO NOT USE

Photodiodes in plastic packages should be given special care. Clear plastic packages are more sensitive to environmental stress than those of black plastic. Storing devices in high humidity can present problems when soldering. Since the rapid heating during soldering stresses the wire bonds and can cause wire to bonding pad separation, it is recommended that devices in plastic packages to be baked for 24 hours at 85°C.

The leads on the photodiode **SHOULD NOT BE FORMED**. If your application requires lead spacing modification, please contact OSI Optoelectronics Applications group at (310)978-0516 before forming a product's leads. Product warranties could be voided.



*Most of our standard catalog products are RoHS Compliant. Please contact us for details

Mechanical Drawings

Mechanical Specifications and Die Topography

1. Parameter Definitions:

A = Distance from top of chip to top of glass.

a = Photodiode Anode.

B = Distance from top of glass to bottom of case.

c = Photodiode Cathode

(Note: cathode is common to case in metal package products unless otherwise noted).

W = Window Diameter.

F.O.V. = Filed of View (see definition below).

2. Dimensions are in inches (1 inch = 25.4 mm).

3. Pin diameters are 0.018 ± 0.002 " unless otherwise specified.

4. Tolerances (unless otherwise noted)

General: $0.XX \pm 0.01$ "

$0.XXX \pm 0.005$ "

Chip Centering: ± 0.010 "

Dimension 'A': ± 0.015 "

5. Windows

All '**UV**' Enhanced products are provided with QUARTZ glass windows, 0.027 ± 0.002 " thick.

All '**XUV**' products are provided with removable windows.

All '**DLS**' PSD products are provided with A/R coated glass windows.

All '**FIL**' photoconductive and photovoltaic products are epoxy filled instead of glass windows.



$$F.O.V. = \tan^{-1} \left(\frac{W}{2A} \right)$$

For Further Assistance
Please Call One of Our Experienced
Sales and Applications Engineers

310-978-0516

OSI Optoelectronics
An OSI Systems Company

- Or -

visit our website at

www.osioptoelectronics.com

Mechanical Specifications

All units in inches. Pinouts are bottom view.

22 TO-5

Products:

XUV-005

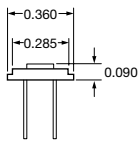

Pin Circle Dia.=0.200



23 TO-8

Products:

XUV-020
XUV-035

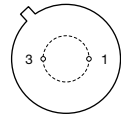
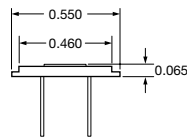

Pin Circle Dia.=0.295



24 TO-8

Products:

PIN-DSIn-TEC

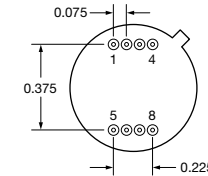
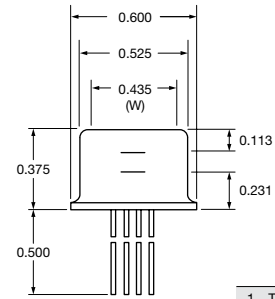

Pinout

- | | |
|---|------------------------|
| 1 | TEC (-) |
| 2 | Thermistor |
| 3 | Thermistor |
| 4 | TEC (+) |
| 5 | Top Silicon, Cathode |
| 6 | Top Silicon, Anode |
| 7 | Bottom InGaAs, Anode |
| 8 | Bottom InGaAs, Cathode |

25 Special Ceramic / Plastic

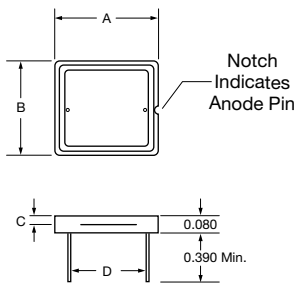

Dimensions

P/N	A	B	C	D
UV-005EQC	0.300	0.236	0.024	0.177
UV-035EQC	0.400	0.350	0.028	0.290
UV-100EQC	0.650	0.590	0.028	0.490
UV-005DQC	0.300	0.236	0.035	0.177
UV-035DQC	0.400	0.350	0.039	0.290
UV-100DQC	0.650	0.590	0.039	0.490
XUV-50C	0.650	0.590	0.027	0.490
XUV-100C	0.650	0.590	0.027	0.490
RD-100	0.650	0.590	0.027	0.490
RD-100A	0.650	0.590	0.027	0.490
UV-35P	0.390	0.345	0.050	0.275
OSD35-LR-A	0.390	0.350	---	0.290
OSD35-LR-D	0.390	0.350	---	0.290

Note: OSD35-prefix packages come with 0.31" (min.) leads

26 TO-8

Products:

RD-100
RD-100A
UV-35P
UV-005EQC
UV-035EQC
UV-100EQC
UV-005DQC
UV-035DQC
UV-100DQC
XUV-50C
XUV-100C
OSD35-LR-A
OSD35-LR-D

Products:

PIN-RD07
PIN-RD15

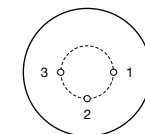
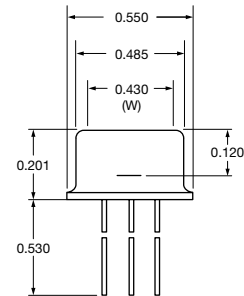

Pin Circle Dia.=0.295

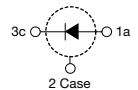

27 Special Plastic

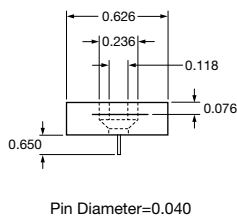
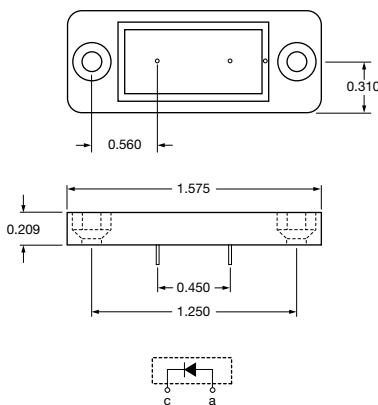

Pin Diameter=0.040

28 BNC

Products:

PIN-220D
PIN-220DP
PIN-220DP/SB

Products:

XUV-100

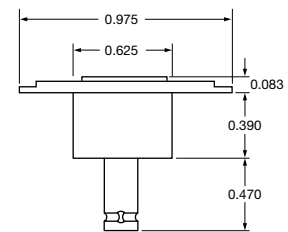

BNC Connector
Outer Contact = Cathode

Distributor



info@amstechnologies.com
www.amstechnologies-webshop.com

Contact us