

Distributor  
  
 info@amstechnologies.com  
 www.amstechnologies-webshop.com  
**Contact us**

ITEM	Material	DESCRIPTION
1	LD8050	D-ZK3M MOLDED ASPHERE
2	3420016	SUS 304L HOUSING
3	3420001	SUS 304L FC/APC CONNECTORS

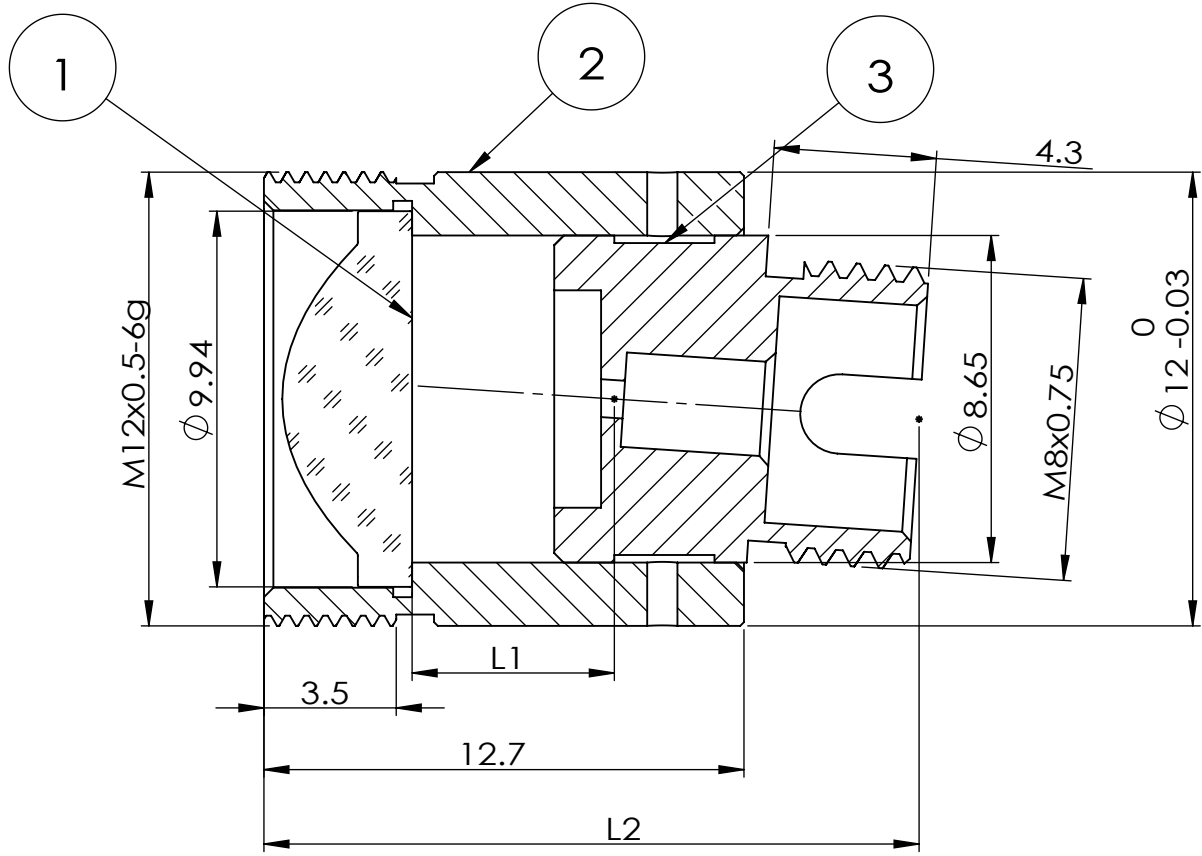

SECTION A-A

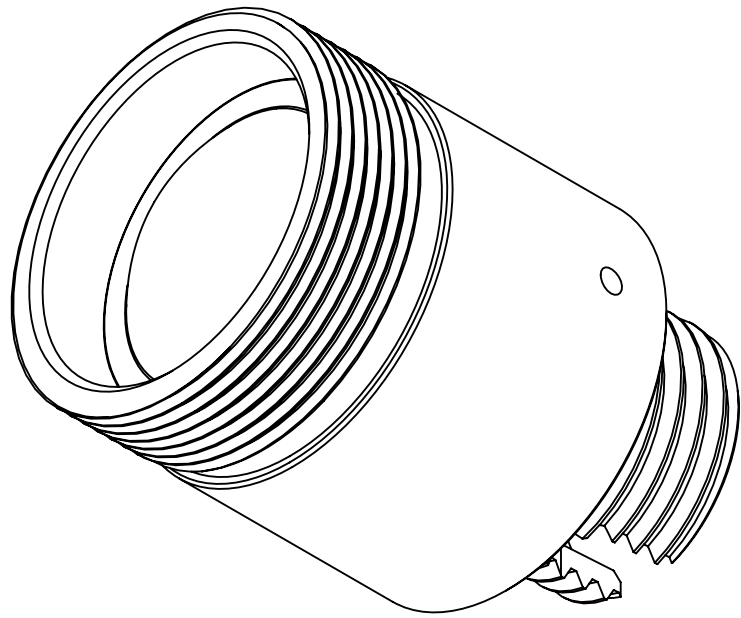
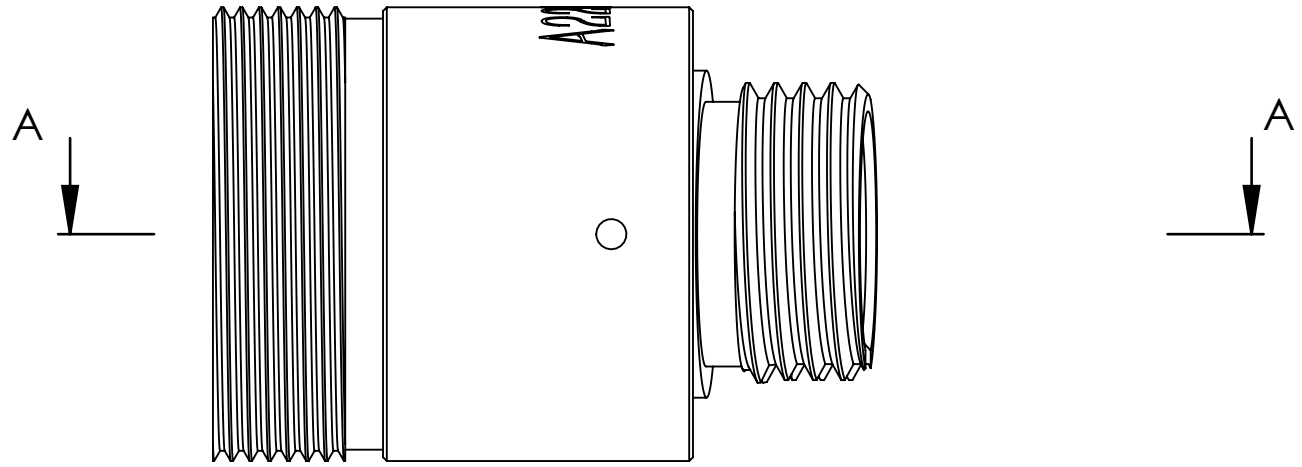

PART NUMBER	$\lambda$	ALIGNMENT FIBER	L1 (mm)	L2 $\pm 0.25$ (mm)
FD805010405	405nm	C405	5.55	17.78
FD805010532	532nm	460HP	5.71	17.94
FD805010633	633nm	SM600	5.77	18.00
FD805010780	780nm	780HP	5.83	18.06
FD805011064	1064nm	HI 1060	5.89	18.12
FD805011310	1310nm	SMF-28e	5.94	18.17
FD805011550	1550nm	SMF-28e	5.98	18.21

DO NOT SCALE DRAWING.

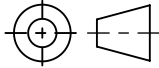
DRAWING PROJECTION. 

**GH Optics (Jiangsu) Co., Ltd.**  
 www.ghoptics.cn  
**GHOPTICS**  
 光皓光学

TITLE: Connectorized Collimators with FC/APC  
 DWG NO. **FD805010633**

NAME	DATE
DRAWN	
CHK'D	
APPV'D	

UNIT: mm    SIZE: A3    SHEET 1 OF 1    REV. A