

THERMOCUBE Liquid-Liquid

Thermoelectric Liquid-Cooled Recirculating Chiller



Distributor



amstechnologies

where technologies meet solutions

info@amstechnologies.com
www.amstechnologies-webshop.com

Contact us



Product Manual

Solid State
COOLING SYSTEMS
Temperature Control...Precisely.

TABLE OF CONTENTS

| | |
|---|-----------|
| SAFETY PRECAUTIONS AND SYMBOLS | 4 |
| SECTION 1 | 5 |
| INTRODUCTION | 5 |
| SECTION 2 | 6 |
| SPECIFICATIONS | 6 |
| SECTION 3 | 9 |
| HOOK UP | 9 |
| 3.1 <i>Electrical Connections (see figure 3)</i> | 10 |
| 3.2 <i>Plumbing Connections (see figure 3)</i> | 10 |
| 3.3 <i>Coolant Fill</i> | 12 |
| SECTION 4 | 13 |
| START UP | 13 |
| SECTION 5 | 13 |
| OPERATION | 13 |
| 5.1 <i>Simple Operation</i> | 14 |
| 5.2 <i>Advanced Operation</i> | 14 |
| 5.3 <i>Alarms</i> | 17 |
| 5.4 <i>Auto-tuning</i> | 17 |
| 5.5 <i>Manual Tuning</i> | 18 |
| 5.6 <i>Drain Procedure</i> | 19 |
| SECTION 6 | 19 |
| SYSTEM ALARMS/TROUBLESHOOTING | 19 |
| SECTION 7 | 21 |
| THERMOCUBE OPTIONS | 21 |
| 7.1 <i>ThermoCube Options and Part Number</i> | 21 |
| 7.2 <i>RS-232 Communications Option</i> | 22 |
| 7.3 <i>Other Options</i> | 25 |
| SECTION 8 | 28 |
| CLEANING YOUR CHILLER | 28 |
| SECTION 9 | 28 |
| TECHNICAL SUPPORT | 28 |
| SECTION 10 | 29 |
| SDS FOR COOLANTS | 29 |
| 10.1 <i>KOOLANCE (27% PROPYLENE GLYCOL/WATER)</i> | 29 |
| 10.2 <i>ETHYLENE GLYCOL</i> | 34 |
| WARRANTY POLICY | 42 |



CE Declaration of Conformity

We: Solid State Cooling Systems
 167 Myers Corners Road
 Wappingers Falls, NY 12590
 USA

declare under our sole responsibility that the

ThermoCube 400L, 400LS, 600L, 600LS (All Models)

Electromagnetic Compatibility (EMC) Directive 2014/30/EU

Low-Voltage (Safety) Directive 2014/35/EU

RoHS Directive 2015/863/EU – R: RoHS Option ONLY

Emissions:

EN 61326-1: 2013 per EN 55011:2009 + A1: 2010 Group 1 Class A

Immunity:

EN 61326-1: 2013 Electrical Equipment for Measurement, Control, and Laboratory Use - EMC

EN 61000-3-2 Harmonics Emissions Class A

EN 61000-3-3 Voltage Fluctuations and Flicker

EN 61000-4-2 Electro-Static Discharge

EN 61000-4-3 Radiated Radio Frequency (RF) Immunity

EN 61000-4-4 Electrical Fast Transient/Burst Immunity

EN 61000-4-5 Surge Immunity

EN 61000-4-6 Conducted RF Disturbance Immunity

EN 61000-4-11 Voltage Dips, Interruptions and Short Variations

EN 61000-6-2 Electromagnetic Compatibility Part 6-2: Immunity for Industrial Environments

Safety:

EN 61010-1: 2010/AMD1:2019

Low Voltage Directive Safety requirements for electrical Equipment for measurement, control, and laboratory use.

| | |
|--|--|
| Lloyd F Wright Chief Technology Officer |  |
| Date | August 19, 2020 |



FCC/ICES/ACMA/UL Declaration of Conformity

We: Solid State Cooling Systems
 167 Myers Corners Road
 Wappingers Falls, NY 12590
 USA

declare under our sole responsibility that the

ThermoCube 400L, 400LS, 600L, 600LS (All Models)

meets the provisions of the directives:

Emissions:

CFR Title 47 FCC Part 15 Subpart B, Class A

ICES-003, Issue 6, Class A

ACMA AS/NZS CISPR 11:2009 + A1:2010 Group 1 Class A

Safety:

UL 61010-1:2012/A1:2018-11

CAN/CSA C22.2 No. 61010-1:2012/A1:2018

Electrical Equipment for Measurement, Control, and
 Laboratory Use; Part 1: General Requirements)

| | |
|--|--|
| Lloyd F Wright Chief Technology Officer |  |
| Date | August 19, 2020 |

SAFETY PRECAUTIONS AND SYMBOLS



Read the SDS for the coolant used and follow **all** safety precautions listed in the SDS prior to removing coolant tubes or opening the fill cap as this could result in contact with the coolant inside.



Caution! Risk of electric shock. Disconnect the power cord prior to servicing. This includes changing a fuse or opening the cover for any reason.

CAUTION

- * Never disassemble the chiller as irreparable damage may occur.
- * Any attempt to open or repair the unit will void the warranty
- * Never store the chiller over 70 °C.
- * Never operate the chiller in ambient temperatures of 40 °C or greater unless the unit has been customized for high ambient operation.
- * Never operate the chiller within 5 °C of the coolant's freezing point.
- * Always use only proper coolants as specified in manual. Solid State Cooling Systems recommends Koolance LIQ-702CL-B (27% propylene glycol and water)
- * Never ship the chiller with coolant inside the liquid cold plate as freezing temperatures may be encountered which would damage the unit. Always pump all coolant out of the chiller prior to shipping.

Symbols Used in this Manual



CAUTION

The red CAUTION equilateral triangle symbol appears throughout the manual. Please follow the important instructions accompanying this symbol to avoid significant damage to the chiller.



WARNING

The red WARNING equilateral triangle symbol appears throughout the manual accompanying certain maintenance and repair activities. Please follow the important instructions accompanying this symbol to avoid situations that could cause injury to the operator or other personnel.

Solid State

COOLING SYSTEMS

Temperature Control...Precisely.

THERMOCUBE LIQUID-LIQUID THERMOELECTRIC CHILLER

PRODUCT MANUAL

SECTION 1

INTRODUCTION

The ThermoCube "Liquid-Liquid" water cooled (400L, 400LS, 600L and 600LS) recirculating chillers utilize thermoelectric technology to deliver from 350 to over 600 Watts of cooling capacity without the use of compressors or refrigerants. The system provides 1 to 3 liters per minute of constant temperature coolant, with PID control for both cooling and heating. With fewer moving parts, the system is highly reliable and energy efficient. NOTE: The ThermoCube 400L, 400LS, 600L and 600LS models require facility cooling water. These units are not air cooled. For air-cooled models see the ThermoCube 200-500

The ThermoCube Liquid-Liquid systems provide stable and precise temperature control for a variety of applications, lasers, low-light CCD cameras, analytical equipment, medical equipment, testing, microelectronics production, and any other application requiring $\pm 0.05^{\circ}\text{C}$ control. The units include a cycling feature where two different temperature set points may be entered with soak time at each temperature and number of cycles desired.

Our redesigned 400LS and 600LS feature Stainless Steel facility water cold plates to help prevent corrosion from marginal or poor quality PCW (Process Chilled Water)

These ThermoCube recirculating chillers are highly customizable, with many different options available, which allow us to specifically configure the system for your particular application.

From conception, The ThermoCube Liquid-Liquid systems have been designed for long life and ease of use. The internal thermoelectric modules have lifetimes greater than 200,000 hours.

SECTION 2

SPECIFICATIONS

| | |
|---|---|
| Operating Range (Set Point): | 5°C to 50°C standard (down to -5°C with low temp option - LT) (up to 65°C with high temp option – HT, 60°C for centrifugal pumps) |
| Ambient Temperature Range: | 10°C to 40°C non-condensing |
| Stability / Repeatability: | ±0.05°C with constant load (even near ambient) |
| Cooling Capacity (typical ¹): | ~350 Watts to more than 600 Watts @ 20°C with 20°C facility water (depending on model - see cooling curves) |
| Noise Level (at 1 meter): | < 48 dBA (pump dependent) |
| Coolant / Process Fluid: | Koolance (27% propylene glycol / water mix) or 27-50% ethylene glycol / water mix. Options available for Fluorinert / Galden or HFE (contact SSCS for advice on other fluids) |
| Process Fluid Fittings: | 1/4" John Guest standard (see options section for other fitting types) |
| Pumps: | Gear pumps or Centrifugal pumps available (see options section for pump types and specifications) |
| Tank Volume: | 300 ml with level sensor |
| Process Wetted Materials: | Process fluid path: Aluminum, stainless steel and polymers (Options available for Copper "-C" and Stainless Steel "S" cold plates) |
| Facility Wetted Materials: | Models 400LS/600LS: Stainless steel and polymers Models 400L/600L: Anodized aluminum (more susceptible to corrosion) |
| Filter: | Optional 5 µm external filter |
| Facility Water (PCW): | 1 gpm recirculated, filtered, treated industrial water, temperature 10 to 25°C, pH 6.5 to 8.2, 100 psig maximum pressure |
| Facility Fittings: | Match process fluid fitting types (or see options page) |
| Dimensions (L x W x H): | 13" x 11" x 13" (32cm x 28cm x 32cm) |
| Weight: | 28 lbs (12.7 kg) for the standard model |
| Power Input: | Universal: 100-240 VAC, 50/60 Hz, 7-5 amps max |
| Controls: | Digital PID controller for heating and cooling |
| Communications: | Keypad or optional RS232 interface |
| Alarms | Temperature, fluid level, system or component failure (display and RS232 option) |
| Standards | TUV listed to UL, CAN/CSA and EN 61010-1, CE 61010-1 (RoHS compatibility is available with the "-R" option) |
| Other Options | (see Section 7 for available options) |
| Warranty | 2 years (diaphragm pumps are 1 year) |

Note 1: Cooling Capacity shown is typical will vary depending on pump type and configuration options.
Capacity will be degraded by as much as 15-20% with -C or -S options

Figure 1
ThermoCube Cooling Capacity by model with 1 gpm 20°C PCW (typical)

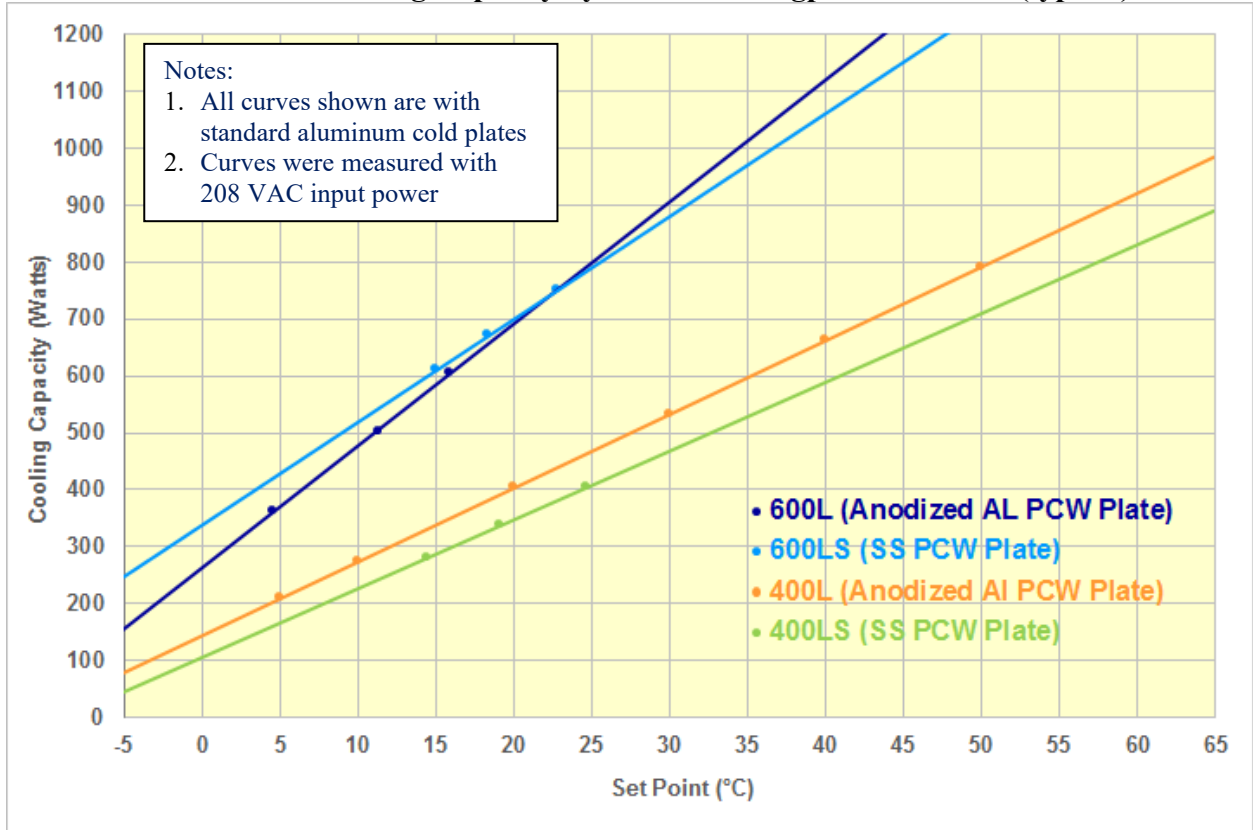

Distributor



amSTECHNOLOGIES
where technologies meet solutions

info@amstechnologies.com
 www.amstechnologies-webshop.com

Contact us

**Figure 2
ThermoCube Pump Performance (typical)**

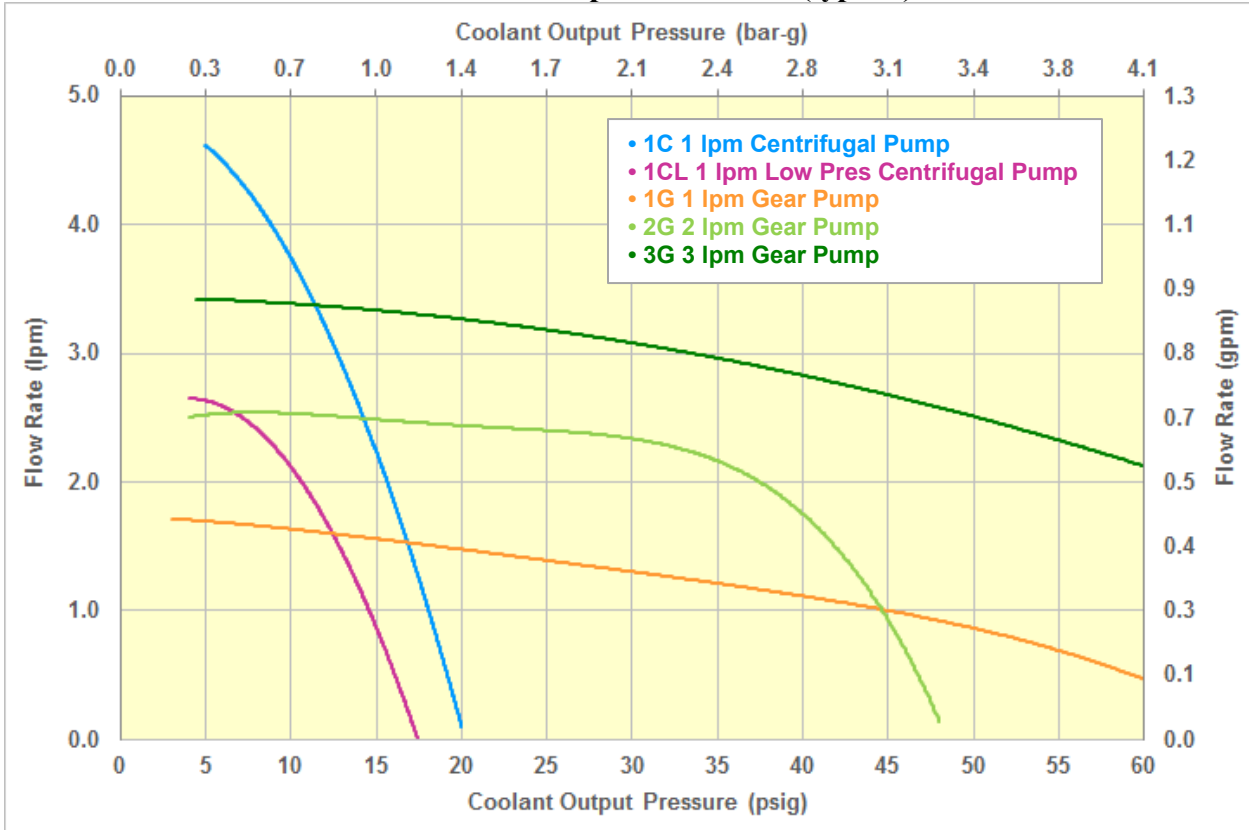

Recommended Pump Flow Operating Ranges:

| Pump Model | Operating Flow Range | Maximum Operating Pressure |
|--|----------------------|------------------------------|
| -1G 1 lpm Gear Pump | 0.9 – 1.7 lpm | 45 psig (3 bar) ¹ |
| -2G 2 lpm Gear Pump | 1.5 – 2.6 lpm | 45 psig (3 bar) ¹ |
| -3G 3 lpm Gear Pump | 2.5 – 3.4 lpm | 60 psig (4 bar) ¹ |
| -1C 1 lpm Centrifugal Pump | 0.9 – 4.6 lpm | 18 psig |
| -1CL 1 lpm Low Pressure Centrifugal Pump | 0.9 – 2.6 lpm | 15 psig |
| -1CL2 1 lpm Low Vibration Centrifugal Pump | 0.9 – 2.6 lpm | 16 psig |
| -1CH 1 lpm High Temperature Centrifugal Pump | 0.9 – 2.1 lpm | 12 psig |

Notes:

1. Contact SSCS if higher pressure is required.
2. Koolance will increase gear pump pressure shown on Figure 2 at a given flow rate.
3. Only gear pumps are compatible with PAO or Fluorinert/Galden. These fluids will also increase gear pump pressure shown on Figure 2 at a given flow rate.
4. Operating at flow rates below the recommended values may lead to unstable temperature control.

SECTION 3

HOOK UP

Figure 3A (Front View)

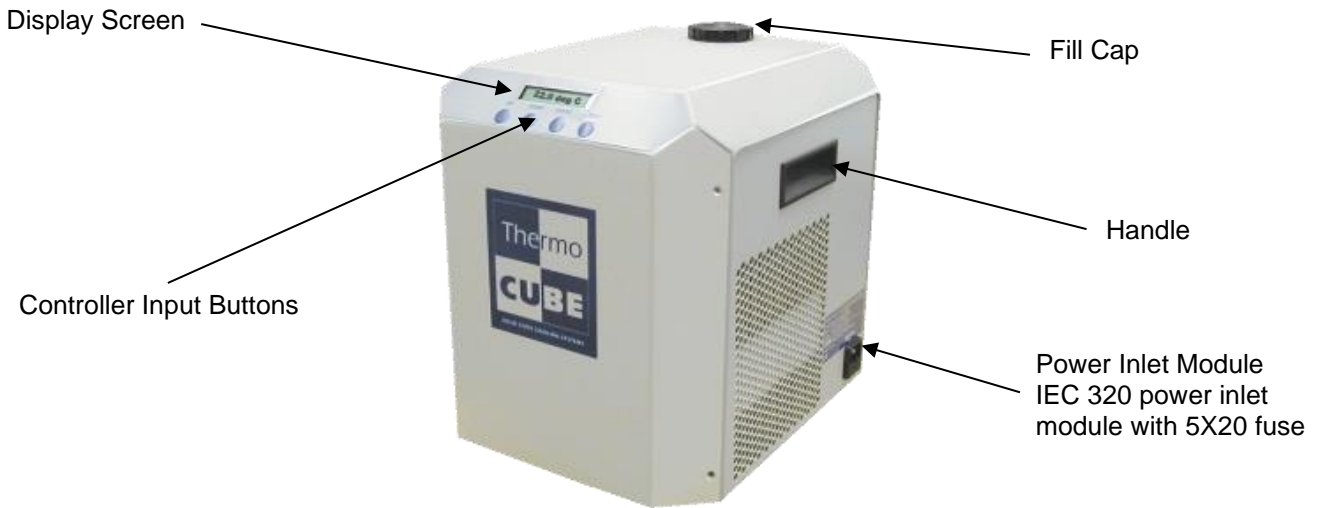

Figure 3B (400L)

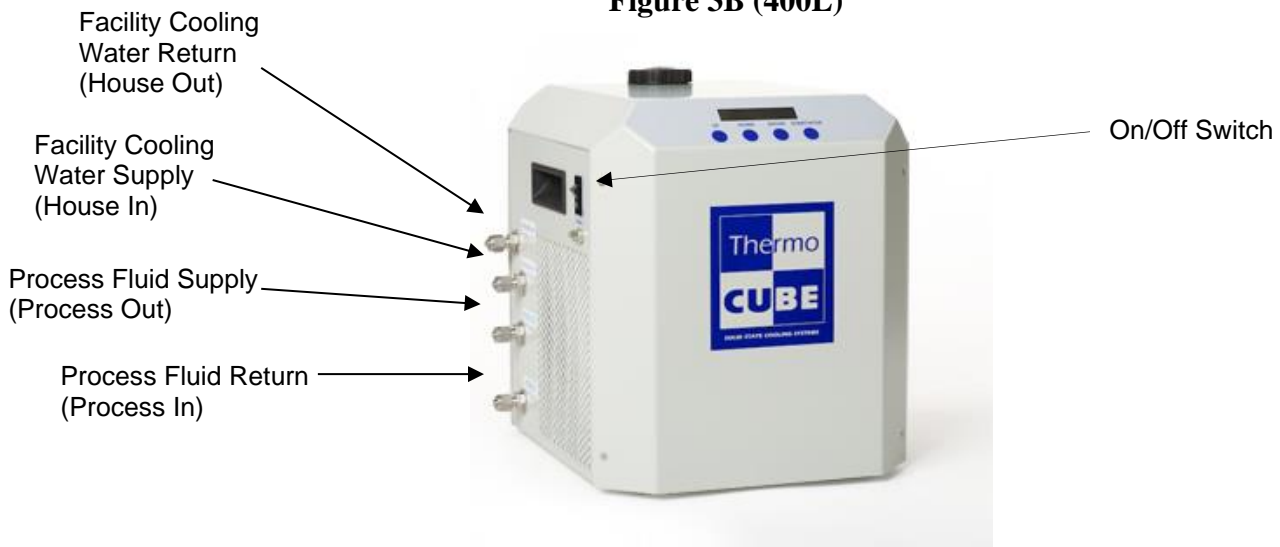
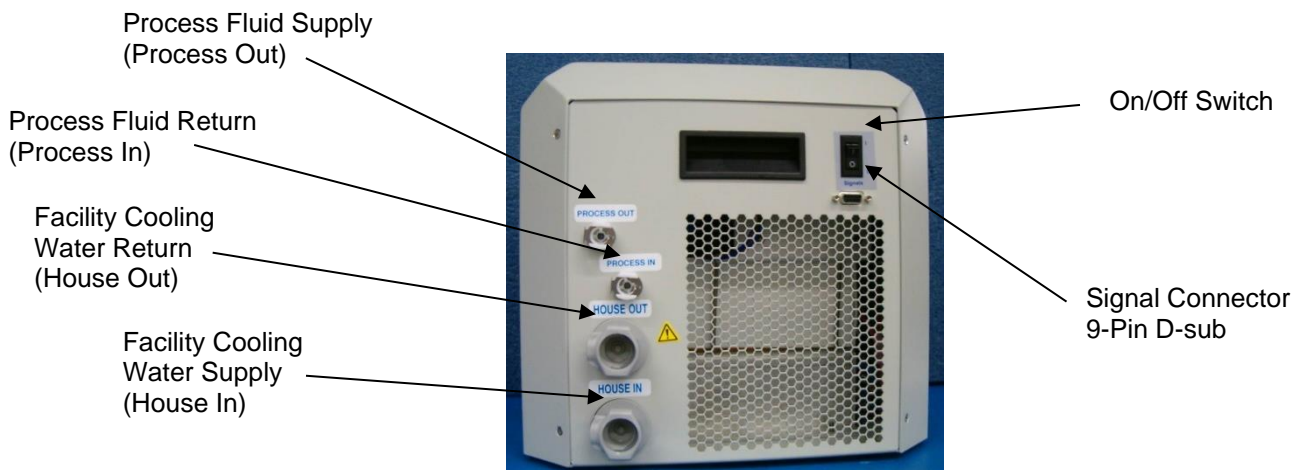

Figure 3C (600L and LS)



3.1 ELECTRICAL CONNECTIONS (SEE FIGURE 3)



WARNING

Electrical Shock
Hazard: Never Plug
in a Line Cord with
Wet Hands

Power: The ThermoCube AC power inlet is an IEC320-C14 socket. Plug the line cord provided into this socket and then into the appropriate 100-240 VAC 50/60 Hz wall outlet. Continuous current draw is rated at 7 amps at 100 VAC or 5 amps at 240 VAC (50/60 Hz). To ensure safe operation of the unit, it is important to ensure that the outlet is properly grounded.

A wide variety of power cords are available to support universal power operation:

| Country / Region | Part Number |
|---------------------------------|-------------|
| USA/Canada | 22-22333-1 |
| Europe | 22-22333-2 |
| Japan | 22-22333-3 |
| UK | 22-22333-4 |
| Israel | 22-22800-1 |
| Australia | 22-23213-1 |
| Korean | 22-23526-1 |
| China (3 prong) | 22-23661-1 |
| NEMA 6-15 208 US Straight | 16-23918-1 |
| NEMA L6-15 208 US Twist | 16-23918-2 |
| Brazil | 22-25122-1 |
| India/South Africa 6A (Type D) | 22-26025-1 |
| India/South Africa 15A (Type M) | 22-26025-2 |

Fuses: 10 amp (5mm x 20mm) GDB quick acting glass, meets IEC 127-2

Replacement Fuse: SSCS#20-22332-10, Allied Electronics #70149445.

Optional Alarms: Alarm signals are TTL signals, normally high (>4 VDC), located on the 9-pin d-subminiature connector as follows:

| | |
|----------------------|-------|
| System Alarm: | Pin 7 |
| Alarm Signal Return: | Pin 8 |
| Temperature Alarm: | Pin 9 |

Optional RS-232: The ThermoCube has an RS-232 communication link option. Connections are made via a 9-pin dsub connector (see section 7 for wiring and communications details).

3.2 PLUMBING CONNECTIONS (SEE FIGURE 3)

Process Fluid (Coolant) Connections: The process fluid inlet (coolant return) and outlet (coolant supply) connections, located on the left side, vary by part number. See section 7 for a list of fitting options. You can use the table in Section 7 to determine the fittings used on your unit from the part number. The default fittings are 1/4" John Guest "push in" style fittings. See figure 4 for directions on using John Guest fittings.

Figure 4: Using John Guest Fittings

John Guest

Time and Labor Savings

In contrast to the lengthy procedure of traditional copper connections and multiple parts in compression fittings, the installation of John Guest **Super Speedfit**® and **Superseal**® products is a simple push-to-connect. There is no need to remake leaky solder joints or adjust awkward compression fittings; an especially important feature when working in confined spaces. Typical installation times can be cut by as much as 40%.

With John Guest **Super Speedfit**® Fittings, Shut-Off Valves and Tubing you can expect:

- Leak proof installations
- Efficient, quick connections (even in tight working quarters)
- Reductions in time and labor cost
- Suitability for plastic and soft metal tubing
- Quick disconnect and reusability



Materials of construction

The fittings are made up of three components:

Bodies are produced in an acetal copolymer or polypropylene.

O' rings are nitrile rubber or EPDM.

Collets are produced in acetal copolymer or polypropylene with stainless steel teeth.

How to make a connection

To make a connection, the tube is simply pushed in by hand. The unique patented John Guest collet locking system then holds the tube firmly in place without deforming it or restricting flow.

1 Cut tube square



Cut the tube square. It is essential that the outside diameter be free of score marks and that burrs and sharp edges be removed before inserting into fitting. For soft thin walled plastic tubing we recommend the use of a tube insert.

2 Insert tube



Fitting grips before it seals. Ensure tube is pushed into the tube stop.

3 Push up to tube stop



Push the tube into the fitting, to the tube stop. The collet (gripper) has stainless steel teeth which hold the tube firmly in position while the 'O' ring provides a permanent leak proof seal.

4 Pull to check secure



Pull on the tube to check that it is secure. It is a good practice to test the system prior to leaving site and/or before use.

Disconnecting

Push in collet and remove tube



To disconnect, ensure the system is depressurized before removing the tube. Push in collet squarely against face of fitting. With the collet held in this position, the tube can be removed. The fitting can then be re-used.

Important Note: Clean process fluid is very important for long life of the ThermoCube. Process fluid should be filtered with a < 20 micron filter.

Facility Water Connections: The facility water Supply (house in) and return house out, located on the left side, also vary by part number. See section 7 for a list of fitting options. You can use the table in Section 7 to determine the fittings used on your unit from the part number. Figure 3B shows optional Swagelok fittings and Figure 3C shows optional CPC fittings. Note that the 600L and 600LS models must use 3/8" fittings. See figure 4 for directions on using John Guest fittings.

Important Note: Clean facility water is very important for long life of the ThermoCube. Water must be filtered (<20 micron filter), treated, re-circulated industrial water with a pH of 6.5-8.2. Using city or tap water may cause calcium deposits inside the heat exchanger that will substantially reduce the chiller's efficiency.

3.3 COOLANT FILL



Read the Coolant SDS
Prior to filling the chiller



CAUTION

Use only recommended
coolants

The coolant fill cap is located at the top rear of the unit. Twist off the cap counter-clockwise to open. Fill reservoir prior to starting unit. Close cap before operating

Recommended Coolants:

Solid State Cooling Systems recommends using Koolance, a pre-mixed 27% propylene glycol/water based coolant containing an algacide and corrosion inhibitors. Though it comes in several colors, SSCS recommends the colorless or blue versions in 700 ml bottles, part number: LIQ-702CL-B (clear) or LIQ-702B-B (blue), as the dyes in the other colored versions can form small particulates when not well mixed.

Contact Koolance for details:

Koolance USA
2840 West Valley Highway North
Auburn, WA 98001
(253) 893-7551

Water or ethylene glycol/water mixtures are also acceptable as coolants.

Note that algae growth can occur when water is used without at least 25% propylene or ethylene glycol.

SECTION 4

START UP

Note: In order to avoid injury or damage, operators must only use this product in the manner specified below.



WARNING

Electrical Shock
Hazard: Never Plug
in a Line Cord with
Wet Hands



CAUTION

Running the
ThermoCube dry
(no fluid) may
damage the pump

Start-up the ThermoCube using the following steps:

- 1) Connect coolant tubing to fluid connections located on the left side of the unit, labeled Process Out (supply) and Process In (return).
- 2) Connect Alarm Signal connector (if option chosen).
- 3) Remove the reservoir cap on top and fill the reservoir to just below the bottom of its neck with coolant. Replace cap.
- 4) Plug line cord into 100 - 240 VAC, 50/60 Hz.
- 5) Turn on switch located on the left side of the unit. The front display should read the current coolant temperature. If the front display reads "TANK LEVEL LOW", add more coolant to the reservoir until the display changes to read the coolant temperature.

Important Notes:

- 1) If the tank level low alarm persists, or if another alarm is displayed, consult section 6.0 of this manual.
- 2) If using an alcohol/water mixture, do not exceed 25% alcohol or the reservoir level float may not rise sufficiently when filled to turn off the tank level low alarm.

SECTION 5

OPERATION

The ThermoCube is operated via the control panel located on the front panel. The control panel has a 16-character LCD display and four input keys: UP, DOWN, ENTER, and START/STOP. These keys work as follows:

| Key | Action |
|------------|---|
| UP | Pressing the UP key raises the parameter value displayed. |
| DOWN | Pressing the DOWN key lowers the parameter value displayed |
| ENTER | Pressing the ENTER key momentarily enters the parameter changed. |
| ENTER | Pressing and holding the ENTER key for 3 seconds causes the chiller to change the display menu (see menu structure) |
| START/STOP | Pressing the START/STOP key turns on temperature control. |
| START/STOP | Pressing the START/STOP key while the chiller is operating turns off temperature control (Operating Mode = *). |

5.1 SIMPLE OPERATION

The ThermoCube comes with preset operating parameters that will work well for most applications. If temperature control at one temperature is desired, follow the steps below.

- 1) Turn on the ThermoCube and wait for display to read TEMP.
- 2) Press the UP or DOWN keys to change SETTEMP1 to the desired set point.
- 3) Press ENTER to accept the value.
- 4) Press the START/STOP key to begin controlling to the temperature just entered (SETTEMP1). The Operating Mode will now show “-” (cooling) or “+” (heating).
- 5) Pressing START/STOP while the unit is controlling temperature will stop temperature control. The Operating Mode will now show “*” for Standby (not controlling).

Caution: Do not externally shut off the flow of coolant for more than a ten second period; pump damage will result if run deadheaded for extended periods of time.

The ThermoCube will now control to the set point temperature. To change the set point temperatures just press the UP or DOWN keys again to change SETTEMP 1 to the new set point, followed by ENTER and then START/STOP. The Operating Mode will now show “-” (cooling) or “+” (heating). If the Operating Mode shows “*”, press START/STOP to begin controlling.

5.2 ADVANCED OPERATION

The ThermoCube controller has three menus: the Status Menu, the Temperature Input Menu and the Parameter Input Menu. The Status Menu shows the chiller operating status and current temperature of fluid leaving the chiller (see figure 5). The Status Menu also allows input of new coolant temperature set-points when the cycling feature is off. The Temperature Input Menu allows input of set point temperatures; soak times, number of cycles if cycling between two temperatures, and an alarm temperature. The Parameter Input Menu allows input of the temperature units; the time units for soak times, the PID parameters and the auto tune function.

The PID parameters have been preset at the factory for most applications. If, however, temperature control is not sufficiently accurate or if overshoot is excessive, the PID parameters may be modified. Unless the user is well versed in PID theory, we recommend calling Solid State Cooling Systems technical support group for assistance.

MENU STRUCTURE:

UP = Increase Value

DOWN = Decrease Value

↵ Press Enter Momentarily

START/STOP = Alternately Starts or Stops temperature control

————> Press & Hold Enter Key 3 Sec to move from one menu to another

| SIMPLE OPERATION | ADVANCED OPERATION | |
|---|---|-------------------------|
| | ————> | ————> |
| STATUS MENU | TEMPERATURE INPUT MENU | PARAMETER INPUT MENU |
| TEMP: XX.X°C (current temp) | SETTEMP1 (set point 1) | TEMPUNIT |
| PRESS UP OR DOWN (change set point) | ↵ SETTIME1 (time at set point 1) Note: SETTIME1 must be set the same as SETTIME2 | ↵ TIMEUNIT |
| SETTEMP1 XX.X°C | ↵ | ↵ |
| ↵ | SETTEMP2 (set point 2) | AUTOTUNE |
| PRESS START/STOP (to begin controlling at SETTEMP1) | ↵ SETTIME2 (time at set point2) Note: SETTIME2 must be set the same as SETTIME1 | ↵ P1 HEAT |
| TEMP: XX.X°C (current temp) | ↵ | ↵ |
| PRESS START/STOP (to stop controlling temperature) | # OF CYCLES (default = 0) | I1 HEAT |
| | ↵ | ↵ |
| | ALARM TEMP | D1 HEAT |
| | ↵ | ↵ |
| | (return to top of menu) | P2 COOL |
| | | ↵ |
| | | I2 COOL |
| | | ↵ |
| | | D2 COOL |
| | | ↵ |
| | | (return to top of menu) |

Press ENTER key once to scroll between menu items (↵).

Press and hold ENTER key for 3 seconds to move between menus (————>).

Pressing and holding ENTER key while in the Parameter Input Menu will return you to the Status Menu.

Notes:

1. If the unit includes the AUTO RESTART option, the unit will begin temperature control when it is first turned on using whatever Set Point was entered when the unit was powered off.
2. If the user enters the temperature input or the parameter input menu and does not press a key for 10 seconds the display will revert back to the Status menu.
3. For temperature cycling (Temperature Input Menu), the dwell times SETTIME1 and SETTIME2 need to be set to the same time. If different times are entered SETTIME2 will be used for both dwell times.
4. If continuous control at one set-point temperature is desired, set # OF CYCLES to zero.

Distributor



amSTECHNOLOGIES
where technologies meet solutions

info@amstechnologies.com
www.amstechnologies-webshop.com

Contact us 

Status Menu: The status menu displays the chiller operating status and coolant temperature. The chiller operating mode is shown in the display's first character: (See Figure 5)

Figure 5: Operating Display

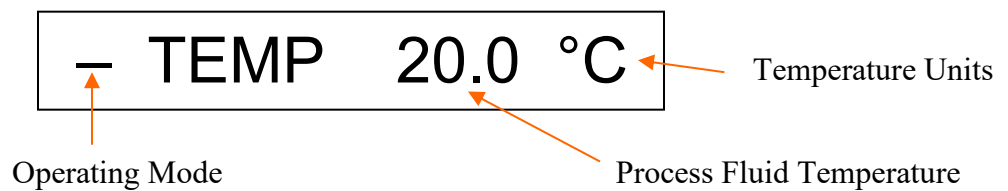

- * = Standby mode, chiller is not controlling temperature
- = Cooling mode, chiller is controlling temperature and process fluid temperature is above the set point
- + = Heating mode, chiller is controlling temperature and process fluid temperature is below the set point

The process fluid (coolant) outlet temperature is shown after TEMP in °C or °F.

Pressing the UP or DOWN keys with the # of cycles set to zero (default) will change the set point temperature upon pressing the ENTER, then the START/STOP key.

Temperature Input Menu: The temperature input menu allows input of operating temperatures, soak times, number of cycles desired, and an optional alarm temperature. Note: If # of cycles is set to zero, only TEMP 1 and ALARM TEMP will be used.

SETTEMP1 = Set-point of first control temperature.

If # OF CYCLES is set to zero, this is the control temperature.

SETTIME1 = Soak time at temperature 1.

Not used if # OF CYCLES is set to zero.

SETTEMP2= Set-point of second control temperature.

Not used if # OF CYCLES is set to zero.

SETTIME2 = Soak time at temperature 2.

Not used if # OF CYCLES is set to zero.

OF CYCLES = Number of cycles between temperature 1 and temperature 2, 0-999 cycles. If set to zero, then the ThermoCube will continuously control at temperature 1.

ALARMTEMP = Alarm temperature range +/- set-point. The unit will output an alarm via dry contact or TTL signals (if available in the configuration), but not via RS-232.

Parameter Input Menu: The parameter input menu allows input of temperature units, time units, PID parameters, and turns on or off auto-tune.

TEMPUNIT = °C or °F

TIMEUNIT = s: seconds, m: minutes, h: hours

AUTOTUNE = ON/OFF.

ON turns on auto-tune where the controller determines PID parameters. Once PID parameters have been determined AUTOTUNE reads OFF.

P1 HEAT = Proportional band for heating, 0-99.9 °C or °F.

P1 HEAT Factory Default Value = 5.6

I1 HEAT = Integral term for heating, 0-999 seconds

I1 HEAT Factory Default Value = 22

D2 HEAT = Derivative term for heating, 0-999 seconds

D2 HEAT Factory Default Value = 2

P2 COOL = Proportional band for cooling, 0-99.9 °C or °F

P2 COOL Factory Default Value = 2.8

I2 COOL = Integral term for cooling, 0-999 seconds

I2 COOL Factory Default Value = 22

D2 COOL = Derivative term for cooling, 0-999 seconds

D2 COOL Factory Default Value = 2

5.3 ALARMS

ThermoCube chillers without an RS-232 communications option have two TTL level alarms, one for temperature and one for system failure:

Temperature: TTL high (>4 VDC) fluid temp below alarm set point
TTL low (<0.5 VDC) fluid temp above alarm set point

System: TTL high (>4 VDC) system operating normally
TTL low (<0.5 VDC) system failure has occurred

A list of system failures causing the system alarm to change to TTL low can be found in Section 6. In the event of a system failure, the alarm type will be shown on the front display.

5.4 AUTO-TUNING

Some ThermoCube models come with an automatic tuning (auto-tune) feature. Changing the PID parameters is normally not recommended unless the RTD probe is moved to a new location. However, the controller can calculate new PID parameters via the auto-tune function.

The following keystrokes initiate the auto-tune function:

- 1) Press and hold the Enter key until the Status Menu changes to the Temperature Input menu.
- 2) Press and hold the Enter key again until the Temperature Input menu changes to the Parameter Input menu.
- 3) Press the Enter key three times. The display should read AUTOTUNE off.
- 4) Press the Up key to change off to on.
- 5) Press and hold the Enter key until the parameter input menu returns to the Status Display.
- 6) Press the Start key once. The left most display character will show the letter A until the auto tune is complete. The ThermoCube will then begin controlling at the set point temperature.

5.5 MANUAL TUNING

For users well versed in PID theory, Solid State Cooling Systems recommends the closed-loop “Ziegler Nichols” method for manually tuning the controller. The method consists of three steps:

- 1) Turn off both the integral and derivative terms for heating and cooling by setting I1, I2, D1, and D2 to zero.
- 2) Set proportional band to 50 °C. Begin controlling the process at the desired set-point temperature. Look for a small-sustained oscillation in the coolant temperature. Observe the status menu operating mode character and note if system is heating (+) or cooling (-). If no oscillation occurs, lower the proportional band in 50% increments until a small oscillation occurs. Write down this proportional band setting (P)
- 3) Measure the “Natural Frequency” (t) of the system in seconds. This is the time required for the temperature oscillation to cycle from one maximum temperature to the next maximum temperature.

Now set the controller input parameters as follows:

P1 HEAT = 2*P if system was heating in step 2.

P1 HEAT = 4*P if system was cooling in step 2.

I1 HEAT = 1.2*t

D1 HEAT = t/8

P2 COOL = P if system was heating in step 2.

P2 COOL = 2*P if system was cooling in step 2.

I2 COOL = 1.2*t

D2 COOL = t/8

5.6 DRAIN PROCEDURE



WARNING

Read the Coolant SDS
prior to draining the
chiller

Process Fluid:

1. Attach a hose to the “Process Out” port of the chiller and place the end of it in a container with at least a 3 liter capacity.
2. Turn the unit on (making sure to hold the drain hose in place) and run it until air starts to shoot out of the hose.
3. Attach the drain hose to the “Process In” port of the chiller
4. Remove the tank cap and allow the liquid in the chiller’s lines to drain out.
5. Replace and tighten the tank cap, then remove the drain hose.
6. Dispose of the coolant in a manner consistent with local regulations.

Facility Cooling Water:

1. Turn off the plant cooling water via valves in the external plumbing.
2. Disconnect the plant cooling water lines from the Thermocube.
3. Attach a hose to the “House In” port of the chiller and place its opposite end into a container with at least a 1 liter capacity.
4. Attach a short vent hose or vented fitting to the “House Out” port of the chiller and allow the water to drain out. You may need to tilt the unit toward the fittings.
5. Remove the drain hose and vent hose.
6. Dispose of the plant cooling water in a manner consistent with local regulations.

SECTION 6

SYSTEM ALARMS/TROUBLESHOOTING



WARNING

Electrical Shock Hazard:
Always unplug the unit
before removing the
cover.

The ThermoCube has multiple system alarms that when triggered will show on the display. When an alarm is displayed the system will not attempt to heat or cool the coolant.

Alarms:

Tank Level Low: Liquid reservoir level is too low. *Unless filling for the first time, check all outside plumbing lines for leaks. Once all leaks are sealed, remove the cap and add more coolant until the alarm disappears.*

RTD Open: The temperature sensor has failed or its connector has come loose. *Turn off the chiller and disconnect the AC power cord. Contact SSCS for a replacement RTD, or for an RMA number to return the unit for RTD replacement.*



Do not attempt to service or repair the unit beyond the troubleshooting checks described in this section without first contacting Solid State Cooling Systems

Fan Fail: The flow of plant cooling water (PCW) is insufficient to cool the thermoelectric heat exchanger. This flow should be equal to or greater than 1gpm for a ThermoCube 400L or 400LS and greater than 1.5gpm for a ThermoCube 600L or 600LS. Check external water lines for kinks or blockages; if none exist Check external water lines for kinks or blockages; if none exist *contact SSCS for tech support, or for an RMA number to return the unit for service/repair.*

Pump Fail: The liquid heat exchanger plate temperature is either too hot or too cold, indicating pump failure, a blockage in the external plumbing lines or operation outside the normal 5°C to 50°C coolant temperature (without –LT or –HT options). *Turn off the ThermoCube and disconnect the AC power cord. Verify that no kinks or blockages exist in plumbing line, both outside and inside the ThermoCube. If no coolant flow blockages exist, contact SSCS for a replacement pump, or for an RMA number to return the unit for pump replacement.*

No Display: If the liquid crystal display does not illuminate upon turning on the ThermoCube, the internal 12 or 24VDC power supply has failed, the diaphragm pump has failed, or the LCD display has failed. *Contact SSCS for an RMA number to return the unit for replacement of the power supply, diaphragm pump, or display.*

Temperature Control Poor: If no other alarms are present, poor temperature control indicates the heat load is too great for the chiller, the TE cooling/heating engine is not receiving power, the PID constants have been corrupted or the chiller needs repair. *First check the PID constant values shown section 5.2 match the factory defaults. If not, change the values to the default values. Otherwise, contact SSCS for technical support.*

Important: The tank level low alarm will automatically reset when the tank is filled. The RTD, Fan and Pump failure alarms will not reset until the system power is turned off.

SECTION 7

THERMOCUBE OPTIONS

7.1 THERMOCUBE OPTIONS AND PART NUMBER

ThermoCube P/N: 10 – CCC – PP – X – YY ZZ – OO

Cooling Capacity Pump Type Power Cord Process Fittings Facility Fittings Other Options

| CCC = Cooling Capacity (choose one): | |
|---|--|
| CCC | Description |
| 400LS | ~350Watts @ 20°C into 20°C PCW with stainless steel facility cold plate |
| 600LS | >600 Watts @ 20°C into 20°C PCW with stainless steel facility cold plate |
| 400L | ~400 Watts @ 20°C into 20°C PCW (old style - anodized AL PCW plates) |
| 600L | >600 Watts @ 20°C into 20°C PCW (old style - anodized AL PCW plates) |

| PP = Pump Type (choose one): | |
|-------------------------------------|---|
| PP | Description |
| -1G | >1 lpm @ 35 psig magnetic drive gear pump, low vibration |
| -2G | >2 lpm @ 35 psig magnetic drive gear pump, low vibration |
| -3GXX | >3 lpm @ 30 psig magnetic drive gear pump, low vibration. Adjustable Flow setting XX = 30 for 3 lpm, 20 for 2 lpm, 10 for 1 lpm or RF for 3 lpm with run / fill switch (two speeds) |
| -1C | Standard centrifugal pump ~2 liter/min @ 15 psig ~1 lpm @ 17 psig, |
| -1CL | Low flow centrifugal pump ~2 liter/min @ 10 psig ~1 lpm @ 12 psig |
| -1CL2 | Medium flow centrifugal pump, ~2 lpm @ 13 psig, ~1 lpm @ 15 psig |

| X = Power Cord (select one) | | |
|------------------------------------|---------------------------------|---------------|
| X | Country / Region | SSCS Part No. |
| 0 | No Power Cord | N/A |
| 1 | USA/Canada | 22-22333-1 |
| 2 | Europe | 22-22332-2 |
| 3 | Japan | 22-22333-3 |
| 4 | UK | 22-22333-4 |
| 5 | Israel | 22-22800-1 |
| 6 | Australia | 22-23213-1 |
| 7 | Korean | 22-23526-1 |
| 8 | China (3 prong) | 22-23661-1 |
| 9 | NEMA 6-15 208 US Straight | 16-23918-1 |
| 10 | NEMA L6-15 208 US Twist | 16-23918-2 |
| 11 | Brazil | 22-25122-1 |
| 12 | India/South Africa 6A (Type D) | 22-26025-1 |
| 13 | India/South Africa 15A (Type M) | 22-26025-2 |

| YY = Process Fluid Fitting Options (no blanks): | |
|--|---|
| YY | Description |
| -JG | John Guest 1/4" x 1/4" Bulkhead |
| -J2 | John Guest 3/8" x 3/8" Bulkhead |
| -CP | 1/4" CPC shut off valve coolant |
| -CP2 | 3/8" CPC process fittings are not available for liquid to liquid models |
| -CPM | 1/4" CPC metal |
| -SW | 1/4" Swagelok kit |
| -S2 | 3/8" Swagelok kit |
| -FN | 1/4" Female NPT Bulkhead |

| ZZ = Facility Water Fitting Options (no blanks): (Note: 600L must use 3/8" facility fittings) | |
|--|---------------------------------|
| ZZ | Description |
| JG | John Guest 1/4" x 1/4" Bulkhead |
| J2 | John Guest 3/8 x 3/8" Bulkhead |
| CP | 1/4" CPC shut off valve coolant |
| CP2 | 3/8" CPC shut off valve coolant |
| CPM | 1/4" CPC metal |
| SW | 1/4" Swagelok kit |
| S2 | 3/8" Swagelok kit |
| FN | 1/4" Female NPT Bulkhead |

| OO = Other Options: | |
|----------------------------|--|
| OO | Description |
| -R2 | RS232 interface controller, improved |
| -EF | 5 micron external liquid filter |
| -SS | Stainless steel tank and stainless steel plumbing (Only avail. with gear pump) |
| -ST | Stainless steel tank with red hose |
| -PT | Preset control temp: (Input temp: ____ °C) |
| -LT | Low temperature (<5°C) operation |
| -HT | High temperature up to 65 °C (60 °C maximum for 1C and 1CL pumps) |
| -DC | Dry contact alarm signals |
| -VD | Vibration dampening material added |
| -AR | Auto restart – software |
| -FL | Set up for Fluorinert or Galden ¹ |
| -C | Copper Process Cold Plate ² (only available on 600LS model with no -SS option) |
| -S | Stainless Steel Process Cold Plate ² (only available on 600LS model, no -SS option) |
| -R | RoHS 2 compliance |
| -### | Custom Engineered Special (sequential number assigned by engineering) |

Note 1: Cooling capacity is reduced as much as 10-15%,
Note 2: Cooling capacity is reduced as much as 15-20%

7.2 RS-232 COMMUNICATIONS OPTION

The ThermoCube comes with a modified (pin-out) RS232 communication port. The chiller uses this port to communicate a comprehensive set of control parameters with a Host PC - these parameters are outlined in Section 7.2. This port is a 9-pin female d-sub connector and is found on the rear panel of the chiller (see Figure 3C and 3D).

-R2: RS-232 Communication Specification

Wiring: Proper wiring depends upon whether the equipment being cooled (the Host) is wired as Data Computer Equipment (DCE) or Data Terminal Equipment (DTE)

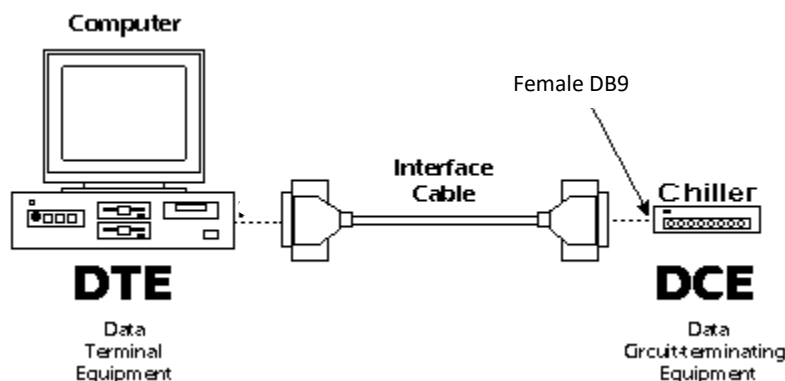

Table 1A: Signal definition and wiring for Host wired as DTE

| Computer/Host/Master Male 9-Pin D-sub Pin # | Chiller / Slave Female 9-Pin D-sub Pin# |
|--|--|
| 2 (Receive – RXD) | 2 (Transmit – TXD) |
| 3 (Transmit – TXD) | 3 (Receive – RXD) |
| 5 (Ground) | 5 (Ground) |

Note: Use a null modem cable if your RS-232 is set up as a DCE.

Communication Specification

| | |
|----------------------------|---|
| Speed: | 9600 baud |
| Data Flow Control: | None |
| Data Format: | 8-bit serial |
| Number of Stop bits: | 1 |
| Parity: | None |
| Transmission Breakdown: | One command byte followed by zero, one, or two data bytes depending on data type. |
| Master/Slave: | ThermoCube is always the SLAVE (DTE) |
| Interrupts Reported: | None, must be polled for status |
| Transmission Length: | ≤ 15 meters |
| Data Update Frequency: | Once per second |
| Maximum Polling Frequency: | Three commands per second |

RS-232 Communication Protocol

Table 2: Command and Data Bytes

| | Bit Position | Description | Bit =1 | Bit = 0 |
|--------------|--|---|---|---|
| Command Byte | Bit 7 (MSB) | Set Remote Control | remote control | local control (chiller) |
| | Bit 6 | Remote On/Off | chiller On | chiller in standby |
| | Bit 5 | Communication Direction | remote to chiller (command from master) | chiller to remote (status from chiller) |
| | Bits 4 – 0 | Parameters being communicated (see table 2) | | |
| Data Bytes | 1 or 2 bytes depending on parameter (see tables 3 and 4) | | | |

Timing: ThermoCube 200/300/400 can accept a maximum of three commands per second

Table 3: Control Parameter

| Bits 4 – 0 | Parameter | No of Data Bytes |
|------------|---|------------------|
| 00001 | Chiller set point 1 temperature | 2 |
| 01001 | Current fluid temperature at chiller coolant output | 2 |
| 01000 | Faults from chiller (fan, pump, RTD failure, etc.) | 1 |

Table 4: Temperature Data Bytes (2 bytes)

The 2 data bytes for the temperature set point and transmission of the current temperature represent the value of the temperature in 0.1°F increments.

For example:

| Temperature (examples) | High Byte | Low Byte | Hexadecimal |
|------------------------|-----------|----------|-------------|
| 0.1 °F | 00000000 | 00000001 | 0001 |
| 1.0 °F | 00000000 | 00001010 | 000A |
| 10.0 °F | 00000000 | 01100100 | 0064 |
| 20.0 °F | 00000000 | 11001000 | 00C8 |
| 30.0 °F | 00000001 | 00101100 | 012C |
| 40.0 °F | 00000001 | 10010000 | 0190 |
| 50.0 °F | 00000001 | 11110100 | 01F4 |
| 60.0 °F | 00000010 | 01011000 | 0258 |
| 70.0 °F | 00000010 | 10111100 | 02BC |

Table 5: Faults Data Byte (1 byte)

0 = OK, 1 = Fault

| Bit Position | Fault Assigned | Hex value when fault is present |
|--------------|-------------------------|---------------------------------|
| 0 | Tank Level Low | 01 |
| 1 | Fan Fail (PCW Flow Low) | 02 |
| 2 | Unassigned | N/A |
| 3 | Pump Fail | 08 |
| 4 | RTD open | 10 |
| 5 | RTD short | 20 |
| 6 | Unassigned | N/A |
| 7 | Unassigned | N/A |

Notes:

- 1) Each data set is independent and can be run separately
- 2) The command byte is always active, so be careful when sending that the three most significant bits (bits 5-7) are set correctly. Bit 7 is remote operation (1 = remote), bit 6 is ON/OFF (1 = ON = unit controlling temperature), bit 5 is Data direction (1 = host to controller, e.g. host sends set point to controller).
- 3) The ThermoCube 200/300/400 can store 8 bytes of transmission and can only handle up to 3 commands per second.
- 4) The ThermoCube does not echo back commands from the host.
- 5) If RS-232 communications does not seem to be functioning, cycle the main power to reset.

RS-232 Communication Examples:

| Example | Communications Sequence |
|--------------------------------------|--|
| 1) Send set point of 25°F to chiller | Host sends command byte = E1 (hex) |
| | Host sends LOW data byte = FA (hex) |
| | Host sends HIGH data byte = 00 (hex) |
| 2) Receive chiller set point | Host sends command byte = C1 (hex) |
| | Chiller sends LOW data byte = set point value in hex (LB) |
| | Chiller sends HIGH data byte = set point value in hex (HB) |
| 3) Receive RTD temperature | Host sends command byte = C9 |
| | Chiller sends LOW data byte = actual temp in hex (LB) |
| | Chiller sends HIGH data byte = actual temp in hex (HB) |
| 4) Receive the faults table | Host sends command byte = C8 |
| | Chiller sends faults data byte = fault data in hex |
| 5) Send Remote Start only | Host sends command byte = E0 |
| 6) Send Remote Stop only | Host sends command byte = A0 |

Distributor



amSTECHNOLOGIES
where technologies meet solutions

info@amstechnologies.com
www.amstechnologies-webshop.com



7.3 OTHER OPTIONS

-AR: Auto-Restart Option

Normally upon power up, the ThermoCube does not start controlling the coolant temperature until the START/STOP button is pressed. With this option selected, the ThermoCube begins controlling the coolant temperature automatically upon power up. After start-up, the START/STOP button operates like normal: pressing this button while running puts the ThermoCube in standby mode (no heating or cooling), pressing this button while in standby mode initiates coolant temperature control.

-C: Copper Cold Plate Option

It is very important to match the wetted metals of the system the ThermoCube is controlling, to minimize any risk of corrosion. If your system uses any copper or brass parts, we recommend the "-C" option to match wetted metals. Note that cooling capacity will be degraded by as much as 15-20% with this option, depending on configuration. THIS OPTION IS ONLY AVAILABLE ON MODEL 600LS. NOT COMPATIBLE WITH -SS OPTION.

-DC: Dry Contact Alarm Option

The ThermoCube can be configured with two normally closed 1 amp 250V dry contact alarm relays instead of the standard TTL alarms, one for system faults and one for temperature exceeding the alarm range. These contacts are wired to the 9-pin dsub connector as follows:

| | |
|----------------------------|-------|
| System Fault Alarm Common: | Pin 6 |
| System Fault Alarm: | Pin 7 |
| Temperature Alarm Common: | Pin 8 |
| Temperature Alarm: | Pin 9 |

If the RS232 option is chosen with dry contact alarm option, then the dry contacts are wired to the 9-pin female dsub connector as follows:

| | |
|----------------------------|-------|
| System Fault Alarm Common: | Pin 6 |
| System Fault Alarm: | Pin 1 |
| Temperature Alarm Common: | Pin 9 |
| Temperature Alarm: | Pin 4 |

-EF: External Filter Option

This option adds an external 5 micron filter to the ThermoCube coolant outlet for systems sensitive to particulate matter in the coolant. Note that this option also dampens coolant flow pulses, producing a smoother coolant flow.

-FL: Fluorinert or Galden



This option is selected to configure the ThermoCube for perfluorinated or hydro fluorinated ether process fluids such as Fluorinert or Galden. Cooling capacity will be degraded by approximately 10-15% with this option, depending on configuration. CAUTION: Make sure this option is included in your ThermoCube configuration if you plan to use these process fluids.

-HT: High Temperature Operation Option

The ThermoCube normally has a 55 °C thermostat on its liquid cold plate that shuts off heating to protect against hot coolant damaging the operator's equipment. The -HT option replaces this thermostat with a 70 °C thermostat and adds insulation to allow operation up coolant temperatures of 65 °C. Note: The Maximum specified temperature for Centrifugal pumps (-1C, and -1CL) is 60 °C.

-LT: Low Temperature Operation Option

The ThermoCube normally has a 5°C thermostat on its liquid cold plate that shuts off cooling to prevent freeze damage when using water as a coolant. The -LT option removes this thermostat and adds insulation to allow operation below the freezing point of water (0°C). Select this option if you plan to regularly run at setpoints below 8-10°C. When selecting this option, the operator must ensure coolants are selected that will not freeze within 5°C of set point. Repairs to thermoelectric heat exchangers damaged by freezing water in Thermocubes with this option selected will not be covered by warranty.

-PT: Preset Control Temperature

With this option the ThermoCube is shipped from the factory with a preset control temperature specified by the customer, and manual entry is disabled. The ThermoCube will always control to the preset temperature and the user no longer has the ability to modify the settings of the unit.

- R: RoHS Compliance



With this option we can configure the ThermoCube to use only RoHS compliant components. RoHS certificates are available with this option upon request.

-RF: Run/Fill Switch Option for 3G (3 lpm Gear Pump)

Thermocubes with -3G pumps with the RF option come with a Run/Fill switch located above the signals connector. This switch allows the user to run the pump at low speed (Fill) during initial filling and then, once all air-bubbles are out of the plumbing lines, increase the pump speed (Run) for normal operation. Failure to run the pump in the fill mode after initial hook-up or with drained plumbing lines can result in water being blown out of the tank from compressed air bubbles in the lines.

Note: The coolant flow rate in the fill mode is approximately 1.3 liters/minute.

-S: Stainless Steel Cold Plate Option

It is very important to match the wetted metals of the system the ThermoCube is controlling, to minimize any risk of corrosion. We recommend using a stainless steel cold plate if you are uncertain about the wetted metals. Note that cooling capacity will be degraded by as much as 15-20% with this option, depending on configuration. THIS OPTION IS ONLY AVAILABLE ON MODEL 600LS. NOT COMPATIBLE WITH -SS OPTION.

-SS: Stainless Steel Plumbing and Tank Option

With this option the standard tank and plumbing are replaced with all stainless steel tank and plumbing. Note: This configuration option is only available with gear pumps.

-ST: Stainless Steel Tank Option

With this option the standard tank is replaced with a stainless steel tank.

-VD: Vibration Dampening Option

This option adds vibration dampening material to interior sheet metal surfaces for applications such as scanning electron microscopes that are highly sensitive to vibrations from pumps and fans. This option is usually combined with the -EF external filter option which dampens vibrations in the coolant flow.

SECTION 8

CLEANING YOUR CHILLER

The exterior surfaces of the ThermoCube may be cleaned with a non-shedding wipe dipped in isopropyl alcohol.

SECTION 9

TECHNICAL SUPPORT

Delighting our customers is our highest priority. Please contact us immediately for technical assistance whenever you have questions or concerns.

Hours: 8 a.m. to 5 p.m. Eastern Time, Monday - Friday

Telephone: (845) 296-1300

Fax: (845) 296-1303

E-mail: info1@sscooling.com

SECTION 10

SDS FOR COOLANTS

10.1 KOOLANCE (27% PROPYLENE GLYCOL/WATER)



Safety Data Sheet – Last updated May 2016

1. IDENTIFICATION

Product: LIQ-702xx Coolant Fluid ("xx" signifies liquid color)

Manufacturer: Koolance Korea

Address: Koolance Bld, 40, Deokcheon-ro 34, Manan-gu, Anyang-si, Gyeonggi-do, Korea 14088

Telephone: (U.S.) +01 253-249-7669, Fax: (U.S.) +01 253-249-7453

Appearance: Liquid for cooling systems. Available in various colors and shipped in plastic bottles or containers.

Usage: For use in cooling systems only. Do not use in foodstuffs, beverages, or in other applications.

2. HAZARD IDENTIFICATION

Globally Harmonized System of Classification and Labeling of Chemicals (GHS)

- Physical Hazard: Not applicable
- Health Hazard: Skin Irritation – Category 2
Eye Irritation – Category 2
- Environmental Hazard: Not applicable

Label elements including precautionary statements.

Symbol:

Signal word: Warning



Hazard statement: H315 – May cause irritation to the skin.

H319 – May cause serious irritation to the eyes.

Prevention: P264 - Wash thoroughly after handling

P280 - Wear protective gloves, clothing, and eye protection.

Responses:

- P302+P352 If on skin: Wash exposure area with plenty of water and soap.
- P305+P351+P338 If in eyes: Rinse continuously with water for several minutes. Remove contact lenses if present and easy to do so. Continue rinsing.
- P337+P313: If skin or eye irritation persists, seek medical attention immediately.
- P362: Remove contaminated clothing and wash before reuse.

Storage / Disposal: P501: Refer to all federal, provincial, state, and local regulation prior to disposition of container and unused contents by reuse, recycle, or disposal.

NFPA Rating (estimated)

Health: 1

Flammability: 1

Reactivity: 0

Water Reactivity: 0



3. COMPOSITION / INFORMATION ON INGREDIENTS

| Ingredients | CAS No. | EINECS No. | Conc. % |
|----------------------|-----------|------------|-----------|
| Distilled Water | 7732-18-5 | 231-791-2 | 70 – 75 |
| Propylene glycol | 57-55-6 | 200-338-0 | 25 – 30 |
| Others (Proprietary) | - | - | 0.2 – 2.0 |

4. FIRST AID MEASURES

- In case of eye contact: Rinse thoroughly with plenty of water for at least 20 minutes. If irritation remains, consult a medical doctor immediately.
- In case of skin contact: Remove contaminated clothing. Wash with soap and plenty of water for at least 20 minutes. If irritation remains, consult a medical doctor immediately.
- If inhaled: Move person to fresh air. If not breathing, give artificial respiration and immediately contact emergency medical assistance.
- If ingested: Never give anything by mouth to an unconscious person. Rinse mouth with water and consult a medical doctor immediately.

Other medical attention: Medical persons should be aware of protective measures for handling.

Potential health effects: May be harmful or fatal if swallowed.

5. FIRE-FIGHTING MEASURES

- Flash Point: 118°C (Cleveland open cup)
- Suitable extinguishing media: Water spray, alcohol-resistant foam, dry chemical, carbon dioxide
- Specific hazards arising from the chemical: No data available
- Special protective equipment for fire fighters:
 - Use water spray to cool unopened containers.
 - Fire fighters should enter area wearing respiratory protection and protective equipment.

6. ACCIDENTAL RELEASE MEASURES

Personal Precautions:

- Ensure adequate ventilation.
- Remove all sources of ignition.
- Avoid contact with skin and eyes.
- Avoid inhalation of vapor, mist, or gas.

Environmental Precautions:

- Follow local regulations.

Methods and materials for containment and clean-up:

- Collect with non-combustible absorbent materials (sand and soil).

7. HANDLING AND STORAGE

Precautions for safe handling:

- Wear protective gloves, clothing, and eye/face protection.
- Do not spray on an open flame or other ignition source.
- Provide forced air ventilation in tanks and confined spaces.
- Avoid contact with skin and eyes.
- Avoid inhalation of vapor, mist, or gas.
- Keep away from sources of ignition. No smoking.

Conditions for safe storage:

- Keep container tightly closed.
- Keep in a dry and well-ventilated place.
- Keep cool.
- Avoid direct sunlight, heat sources, and strong oxidizing agents.

8. EXPOSURE CONTROL / PERSONAL PROTECTION

Conditions for safe storage:

- KOSHA: No data available
- US ACGIH: No data available

Appropriate engineering controls:

- Respiratory protection: Approved respirator equipped with cartridge for organic vapors
- Eye protection: Protective goggles
- Hand protection: Chemical resistant gloves

9. PHYSICAL AND CHEMICAL PROPERTIES

- State: Liquid at 20°C
- Flash Point: 118°C (Cleveland open cup). No flash occurred under 93°C (Tag closed cup)
- pH: 7.0 – 8.0 at 20°C; Sample H₂O = 1:5 (V/V)
- Viscosity: 2.3 mPa x s (cP) at 20°C
- Density: 1.03 at 20°C
- Water solubility: Soluble at 20°C
- Explosive properties: No self-reaction hazard; UN TDG test & criteria – Test E3
- Autoignition temperature: No spontaneous combustion under 300°C
- Boiling point (initial): >98°C
- Melting range: No data available
- Vapor pressure: No data available
- Oxidizing properties: No data available
- Partition coefficient (n-octanol/water): No data available
- Evaporation rate: No data available
- Decomposition temperature: No data available
- Lower explosion limit / Upper explosion limit: No data available

Distributor



amSTECHNOLOGIES
where technologies meet solutions

info@amstechnologies.com
www.amstechnologies-webshop.com

Contact us



10. STABILITY AND REACTIVITY

Chemical stability:

Stable under recommended storage conditions.

Conditions to avoid:

Direct sunlight, heat, flames, and sparks.

Materials to avoid:

Strong oxidizing agents.

Hazardous decomposition products:

Carbon oxides

11. TOXICOLOGICAL INFORMATION

- Acute toxicity (Calculated):

| | | |
|------------|--------|---------------------|
| Oral | rat | LD50 : 23,779 mg/kg |
| Skin | rabbit | LD50 : 38,021 mg/kg |
| Inhalation | rat | LC50 : 145 mg/kg |
- Skin irritation: Irritating (Calculated, Category 2)
- Eye irritation: Irritating (Calculated, Category 2)
- Respiratory sensitization: No data available
- Skin sensitization: No data available
- Germ cell mutagenicity: No data available
- Carcinogenicity: Not classifiable; from IARC / EC ESIS
- Reproductive Toxicity: No data available
- Specific target organ toxicity – single exposure (GHS): No data available
- Specific target organ toxicity – repeated exposure (GHS): No data available
- Aspiration hazard: No data available

12. ECOLOGICAL INFORMATION

- Acute toxicity (Calculated):

| | |
|------------|--|
| Fish | LC50 : 8,700mg/l 96hr Pimephales promelas |
| Crustacean | LC50: 7,921mg/l 48hr Daphnia magna |
| Bird | EC50: 1,634mg/l 72hr Selenastrum capricornutum |
- Persistence and degradability: No data available
- Bioaccumulative potential: No data available
- Mobility in soil: No data available
- Other adverse effects: No data available

13. DISPOSAL CONSIDERATIONS

Disposal consideration:

Observe all environmental regulations.

Disposal precaution:

Avoid disposing in the environment.

14. TRANSPORT INFORMATION

- TSCA: All ingredients are listed on the TSCA inventory
- DOT Classification: Not a DOT controlled material (U.S.)
- UN TDG: Not dangerous goods
- IMDG: Not dangerous goods
- IATA: Not dangerous goods
- Marine pollution: Not applicable
- Special precaution:
 - Fire EmS Guide: F-E (Recommendation)
 - Spillage EmS Guide: Not dangerous goods

15. REGULATORY INFORMATION

- Korea Industrial Safety and Health Act (GHS): Eye irritation – Category 2
- Korea Industrial Safety and Health Act (GHS): Skin irritation – Category 2
- Korea Hazardous Materials Safety Control Act: Not hazardous material
- Korea Toxic Chemicals Control Act: Not a toxic chemical
- Korea Persistent Organic Pollutants Control Act: Not applicable
- US OSHA Hazards (GHS): Eye irritation
- US OSHA Hazards (GHS): Skin irritation

16. OTHER INFORMATION

Last Updated: March, 2015

References:

- GHS Classification: EC ESIS, US NLM
- Physical and chemical properties: EC ESIS, US NLM
- Transport information: EC ESIS, US NLM
- Toxic and ecological information: OECD SIDS, IUCLID, US NLM, IARC, EC ESIS, CCRIS

Acronyms and Websites:

- EC ESIS : European chemical Substances Information System, <http://esis.jrc.ec.europa.eu/>
- IUCLID : International Uniform Chemical Information Database, <http://esis.jrc.ec.europa.eu/>
- US NLM : U.S. National Library of Medicine, <http://chem.sis.nlm.nih.gov/chemidplus/>
- HSDB : US Hazardous Substances Data Bank, <http://toxnet.nlm.nih.gov/>
- CCRIS : US Chemical Carcinogenesis Research Information System, <http://toxnet.nlm.nih.gov/>
- IARC : International Agency for Research on Cancer, <http://monographs.iarc.fr>

This SDS is composed with reference to documents and criteria provided by KOSHA. The information above is believed to be accurate and represents the best information currently available to us. However, we make no warranty of merchantability or any other warranty, express or implied, with respect to such information, and we assume no liability resulting from its use. Users should make their own investigations to determine the suitability of the information for their particular purposes. In no event shall Koolance be liable for any claims, losses, or damages of any third party or for lost profits or any special, indirect, incidental, consequential or exemplary damages, howsoever arising, even if Koolance has been advised of the possibility of such damages.

10.2 ETHYLENE GLYCOL



SAFETY DATA SHEET

Creation Date: 02-Feb-2010

Revision Date: 17-Jan-2018

Revision Number 4

1. Identification

| | |
|-----------------------------|---|
| Product Name | Ethylene glycol |
| Cat No. : | E177-4; E177-20 |
| CAS-No | 107-21-1 |
| Synonyms | Monoethylene glycol; 1,2-Ethanediol |
| Recommended Use | Laboratory chemicals. |
| Uses advised against | Not for food, drug, pesticide or biocidal product use |

Details of the supplier of the safety data sheet**Company**

Fisher Scientific
One Reagent Lane
Fair Lawn, NJ 07410
Tel: (201) 796-7100

Emergency Telephone Number

CHEMTRECO, Inside the USA: 800-424-9300
CHEMTRECO, Outside the USA: 001-703-527-3887

2. Hazard(s) Identification**Classification**

This chemical is considered hazardous by the 2012 OSHA Hazard Communication Standard (29 CFR 1910.1200)

| | |
|--|------------|
| Acute oral toxicity | Category 4 |
| Specific target organ toxicity (single exposure) | Category 3 |
| Target Organs - Central nervous system (CNS). | |
| Specific target organ toxicity - (repeated exposure) | Category 2 |

Label Elements**Signal Word**

Warning

Hazard Statements

Harmful if swallowed
May cause drowsiness or dizziness
May cause damage to organs through prolonged or repeated exposure

**Precautionary Statements****Prevention**

Wash face, hands and any exposed skin thoroughly after handling

Do not eat, drink or smoke when using this product

Do not breathe dust/fume/gas/mist/vapors/spray

Use only outdoors or in a well-ventilated area

Response

Get medical attention/advice if you feel unwell

Inhalation

IF INHALED: Remove victim to fresh air and keep at rest in a position comfortable for breathing

Call a POISON CENTER or doctor/physician if you feel unwell

Ingestion

IF SWALLOWED: Call a POISON CENTER or doctor/physician if you feel unwell

Rinse mouth

Storage

Store in a well-ventilated place. Keep container tightly closed

Store locked up

Disposal

Dispose of contents/container to an approved waste disposal plant

Hazards not otherwise classified (HNOC)

WARNING. Reproductive Harm - <https://www.p65warnings.ca.gov/>.

3. Composition/Information on Ingredients

| Component | CAS-No | Weight % |
|-----------------|----------|----------|
| Ethylene Glycol | 107-21-1 | >95 |

4. First-aid measures

| | |
|--|--|
| Eye Contact | Rinse immediately with plenty of water, also under the eyelids, for at least 15 minutes. Get medical attention. |
| Skin Contact | Wash off immediately with plenty of water for at least 15 minutes. Get medical attention immediately if symptoms occur. |
| Inhalation | Move to fresh air. Do not use mouth-to-mouth method if victim ingested or inhaled the substance; give artificial respiration with the aid of a pocket mask equipped with a one-way valve or other proper respiratory medical device. Get medical attention immediately if symptoms occur. If not breathing, give artificial respiration. |
| Ingestion | Do not induce vomiting. Call a physician or Poison Control Center immediately. |
| Most important symptoms and effects | Breathing difficulties. |
| Notes to Physician | Treat symptomatically |

5. Fire-fighting measures

| | |
|---|--|
| Suitable Extinguishing Media | Use water spray, alcohol-resistant foam, dry chemical or carbon dioxide. |
| Unsuitable Extinguishing Media | No information available |
| Flash Point | 111 °C / 231.8 °F |
| Method - | DIN 51758 |
| Autoignition Temperature | 413 °C / 775.4 °F |
| Explosion Limits | |
| Upper | 15.30 vol % |
| Lower | 3.20 vol % |
| Sensitivity to Mechanical Impact | No information available |
| Sensitivity to Static Discharge | No information available |

Specific Hazards Arising from the Chemical

Thermal decomposition can lead to release of irritating gases and vapors. Keep product and empty container away from heat and sources of ignition.

Hazardous Combustion Products

Carbon monoxide (CO) Carbon dioxide (CO₂)

Protective Equipment and Precautions for Firefighters

As in any fire, wear self-contained breathing apparatus pressure-demand, MSHA/NIOSH (approved or equivalent) and full protective gear.

NFPA

| | | | |
|---------------|---------------------|--------------------|-------------------------|
| Health | Flammability | Instability | Physical hazards |
| 2 | 1 | 1 | N/A |

6. Accidental release measures

| | |
|---|--|
| Personal Precautions | Ensure adequate ventilation. Use personal protective equipment. |
| Environmental Precautions | Should not be released into the environment. See Section 12 for additional ecological information. |
| Methods for Containment and Clean Up | Soak up with inert absorbent material. Keep in suitable, closed containers for disposal. |

7. Handling and storage

| | |
|-----------------|---|
| Handling | Wear personal protective equipment. Ensure adequate ventilation. Do not breathe vapors or spray mist. Avoid contact with skin, eyes and clothing. |
| Storage | Keep containers tightly closed in a dry, cool and well-ventilated place. Keep away from heat and sources of ignition. |

8. Exposure controls / personal protection

Exposure Guidelines

| Component | ACGIH TLV | OSHA PEL | NIOSH IDLH | Mexico OEL (TWA) |
|-----------------|---|---|------------|--------------------------------|
| ethylene glycol | TWA: 25 ppm STEL: 50 ppm STEL: 10 mg/m ³ | (vacated) Ceiling: 50 ppm (Vacated) Ceiling: 125 mg/m ³ | | Ceiling: 100 mg/m ³ |

Legend

ACGIH - American Conference of Governmental Industrial Hygienists

OSHA - Occupational Safety and Health Administration

Engineering Measures Ensure adequate ventilation, especially in confined areas. Ensure that eyewash stations and safety showers are close to the workstation location.

Personal Protective Equipment

Eye/face Protection Wear appropriate protective eyeglasses or chemical safety goggles as described by OSHA's eye and face protection regulations in 29 CFR 1910.133 or European Standard EN166.

Skin and body protection Wear appropriate protective gloves and clothing to prevent skin exposure.

Respiratory Protection Follow the OSHA respirator regulations found in 29 CFR 1910.134 or European Standard EN 149. Use a NIOSH/MSHA or European Standard EN 149 approved respirator if exposure limits are exceeded or if irritation or other symptoms are experienced.

Hygiene Measures Handle in accordance with good industrial hygiene and safety practice.

9. Physical and chemical properties

| | |
|---|--|
| Physical State | Viscous liquid |
| Appearance | Liquid |
| Odor | Colorless |
| Odor Threshold | Odorless |
| pH | No information available |
| Melting Point/Range | 5.5-7.5 50% aq. sol |
| Boiling Point/Range | -13 °C / 8.6 °F |
| Flash Point | 196 - 198 °C / 384.8 - 388.4 °F @ 760 mmHg |
| Method - | 111 °C / 231.8 °F |
| Evaporation Rate | DIN 51758 |
| Flammability (solid,gas) | No information available |
| Flammability or explosive limits | Not applicable |
| Upper | 15.30 vol % |
| Lower | 3.20 vol % |
| Vapor Pressure | 0.12 mmHg @ 20 °C |
| Vapor Density | 2.14 (Air = 1.0) |
| Specific Gravity | 1.113 |
| Solubility | miscible |
| Partition coefficient; n-octanol/water | No data available |
| Autoignition Temperature | 413 °C / 775.4 °F |
| Decomposition Temperature | > 500°C |
| Viscosity | 21 cP (20°C) |
| Molecular Formula | C2 H6 O2 |
| Molecular Weight | 62.06 |

10. Stability and reactivity

| | |
|---|---|
| Reactive Hazard | None known, based on information available |
| Stability | Hygroscopic. |
| Conditions to Avoid | Incompatible products. Excess heat. Exposure to moist air or water. |
| Incompatible Materials | Strong oxidizing agents, Strong acids, Strong bases, Aldehydes |
| Hazardous Decomposition Products | Carbon monoxide (CO), Carbon dioxide (CO2) |
| Hazardous Polymerization | Hazardous polymerization does not occur. |
| Hazardous Reactions | None under normal processing. |

11. Toxicological Information

Acute Toxicity

Product Information

Component Information

| Component | LD50 Oral | LD50 Dermal | LD50 Inhalation |
|-----------------|--------------------|--|-----------------|
| Ethylene glycol | 7712 mg/kg (Rat) | 9530 µL/kg (Rabbit) 10600 mg.kg (Rat) | Not listed |

Toxicologically Synergistic Products No information available

Delayed and immediate effects as well as chronic effects from short and long-term exposure

Irritation May cause eye, skin, and respiratory tract irritation

Sensitization No information available

Carcinogenicity The table below indicates whether each agency has listed any ingredient as a carcinogen.

| Component | CAS-No | IARC | NTP | ACGIH | OSHA | Mexico |
|-----------------|----------|------------|------------|------------|------------|------------|
| Ethylene glycol | 107-21-1 | Not listed | Not listed | Not listed | Not listed | Not listed |

Mutagenic Effects No information available

Reproductive Effects No information available.

Developmental Effects No information available.

Teratogenicity No information available.

STOT - single exposure Central nervous system (CNS)

STOT - repeated exposure Kidney Liver

Aspiration hazard No information available

Symptoms/effects, both acute & delayed No information available

Endocrine Disruptor Information No information available

Other Adverse Effects The toxicological properties have not been fully investigated.

12. Ecological Information

Ecotoxicity

Do not empty into drains.

| Component | Freshwater Algae | Freshwater Fish | Microtox | Water Flea |
|-----------------|--|---|------------|---|
| Ethylene glycol | EC50: 6500 - 13000 mg/L, 96h (Pseudokirchneriella subcapitata) | LC50: = 16000 mg/L, 96h static (Poecilia reticulata) LC50: 40000 - 60000 mg/L, 96h static (Pimephales promelas) LC50: = 40761 mg/L, 96h static (Oncorhynchus mykiss) LC50: = 41000 mg/L, 96h (Oncorhynchus mykiss) LC50: 14 - 18 mL/L, 96h static (Oncorhynchus mykiss) LC50: = 27540 mg/L, 96h static (Lepomis macrochirus) | Not listed | EC50: = 46300 mg/L, 48h (Daphnia magna) |

| | |
|--------------------------------------|---|
| Persistence and Degradability | Persistence is unlikely |
| Bioaccumulation/ Accumulation | No information available. |
| Mobility | Will likely be mobile in the environment due to its water solubility. |

| Component | log Pow |
|-----------------|---------|
| Ethylene glycol | -1.93 |

13. Disposal considerations

| | |
|-------------------------------|---|
| Waste Disposal Methods | Chemical waste generators must determine whether a discarded chemical is classified as a hazardous waste. Chemical waste generators must also consult local, regional, and national hazardous waste regulations to ensure complete and accurate classification. |
|-------------------------------|---|

14. Transport information

| | |
|-----------------|---------------|
| DOT | Not regulated |
| TDG | Not regulated |
| IATA | Not regulated |
| IMDG/IMO | Not regulated |

15. Regulatory information

All of the components in the product are on the following Inventory lists: X = listed

International Inventories

| Component | TSCA | DSL | NDSL | EINECS | ELINCS | NLP | PICCS | ENCS | AICS | IECSC | KECL |
|-----------------|------|-----|------|-----------|--------|-----|-------|------|------|-------|------|
| Ethylene glycol | X | X | - | 203-473-3 | - | | X | X | X | X | X |

Legend:

X - Listed

E - Indicates a substance that is the subject of a Section 5(e) Consent order under TSCA.

F - Indicates a substance that is the subject of a Section 5(f) Rule under TSCA.

N - Indicates a polymeric substance containing no free-radical initiator in its inventory name but is considered to cover the designated polymer made with any free-radical initiator regardless of the amount used.

P - Indicates a commenced PMN substance

R - Indicates a substance that is the subject of a Section 6 risk management rule under TSCA.

S - Indicates a substance that is identified in a proposed or final Significant New Use Rule

T - Indicates a substance that is the subject of a Section 4 test rule under TSCA.

XU - Indicates a substance exempt from reporting under the Inventory Update Rule, i.e. Partial Updating of the TSCA Inventory Data Base Production and Site Reports (40 CFR 710(B)).

Y1 - Indicates an exempt polymer that has a number-average molecular weight of 1,000 or greater.

Y2 - Indicates an exempt polymer that is a polyester and is made only from reactants included in a specified list of low concern reactants that comprises one of the eligibility criteria for the exemption rule.

U.S. Federal Regulations

TSCA 12(b) Not applicable

SARA 313

| Component | CAS-No | Weight % | SARA 313 Threshold Values % |
|-----------------|----------|----------|-----------------------------|
| Ethylene glycol | 107-21-1 | >95 | 1.0 |

SARA 311/312 Hazard Categories See section 2 for more information

CWA (Clean Water Act) Not applicable

Clean Air Act

| Component | HAPS Data | Class 1 Ozone Depleters | Class 2 Ozone Depleters |
|-----------------|-----------|-------------------------|-------------------------|
| Ethylene glycol | X | | - |

OSHA Occupational Safety and Health Administration Not applicable

CERCLA This material, as supplied, contains one or more substances regulated as a hazardous substance under the Comprehensive Environmental Response Compensation and Liability Act (CERCLA) (40 CFR 302)

| Component | Hazardous Substances RQs | CERCLA EHS RQs |
|-----------------|--------------------------|----------------|
| Ethylene glycol | 5000 lb | - |

California Proposition 65 This product does not contain any Proposition 65 chemicals

U.S. State Right-to-Know Regulations

| Component | Massachusetts | New Jersey | Pennsylvania | Illinois | Rhode Island |
|-----------------|---------------|------------|--------------|----------|--------------|
| Ethylene glycol | X | X | X | X | - |

U.S. Department of Transportation

Reportable Quantity (RQ): Y
 DOT Marine Pollutant N
 DOT Severe Marine Pollutant N

U.S. Department of Homeland Security

This product does not contain any DHS chemicals.

Other International Regulations

Mexico - Grade Slight risk, Grade 1

16. Other information

Prepared By Regulatory Affairs
 Thermo Fisher Scientific
 Email: EMSDS.RA@thermofisher.com

Creation Date 02-Feb-2010

Revision Date 17-Jan-2018

Print Date 17-Jan-2018

Revision Summary This document has been updated to comply with the US OSHA HazCom 2012 Standard replacing the current legislation under 29 CFR 1910.1200 to align with the Globally Harmonized System of Classification and Labeling of Chemicals (GHS).

Disclaimer

The information provided in this Safety Data Sheet is correct to the best of our knowledge, information and belief at the date of its publication. The information given is designed only as a guidance for safe handling, use, processing, storage, transportation, disposal and release and is not to be considered a warranty or quality specification. The information relates only to the specific material designated and may not be valid for such material used in combination with any other materials or in any process, unless specified in the text

End of SDS

WARRANTY POLICY

This ThermoCube is covered under a two-year parts and labor warranty from the date of shipment, assuming proper use and maintenance of the unit. All warranty work shall be performed at Solid State Cooling Systems' facility, currently located in Wappingers Falls, NY, USA and requires pre-authorization by SSCS. Malfunctioning products should be returned to Solid State Cooling Systems by the method described below. Solid State Cooling Systems will provide a Failure Analysis Report to the customer and will determine if the problem is covered under the warranty.

Warranty Coverage:

Products with defects in components or manufacturing which are reported to Solid State Cooling Systems before the end of the warranty period will be repaired or replaced at no cost (see below for reporting requirements). The warranty period begins on the date the product was initially shipped from Solid State Cooling Systems' factory.

Excluded from Warranty:

Excluded from warranty is any damage caused to the product occurring during, but not limited to, such events as shipment, installation, storage, or usage occurring during a situation specifically cautioned against or noted in the product manual.

Specific situations, which invalidate the warranty, include (but are not limited to):

- Operating the unit outside the stated specification ranges
- Removing the serial number label.
- Any disassembly (partial or complete) of the product.
- Changing any components of the product.
- Subjecting the product to temperatures below the freezing point of the coolant used.
- Subjecting any product to temperature, voltage, current, or pressure (internal or external) greater than that specified in the product manual.
- Any actions prohibited in the "Caution" section of the product manual.

Returned Goods Procedure and Reporting Requirements

Before a failed product is returned to the factory, a Returned Materials Authorization (RMA) number must be obtained from Customer Service at (845) 296-1300. The date the RMA is requested will be the reporting date noted and relevant to the warranty. Products, which have received an RMA, must be received at SSCS's factory, within 30 days or the reporting date will be moved ahead 30 days and a new 30-day waiting period will begin. Customers shall pay shipping cost of returning any unit to SSCS and SSCS shall pay shipping cost of returning any unit repaired under warranty to the customer.

All out of warranty returned goods will require an evaluation purchase order prior to receipt at Solid State Cooling Systems. The evaluation costs will depend on product model and will be deducted from the cost of any repairs required.

