



# OZ Optics

shop.ozoptics.com  
www.ozoptics.com

## HERMETICALLY SEALABLE PATCHCORDS WITH GLASS SOLDER USA PATENT: 7058275

### Features:

- High polarization extinction ratios up to 30dB available
- Singlemode, multimode or polarization maintaining fibers
- Single or multiple fiber designs up to 24 channels
- Ribbon fiber versions up to 24 channels available
- Alternative to fiber metalization methods
- Can be installed into packages with standard solders
- Available terminated with round or rectangular ferrules
- Designed to meet Telcordia requirements (GR 1221-core, GR 326-core)
- Custom configurations can be designed
- Large volume manufacturing capacity
- Low cost

### Applications:

- Laser diode packaging
- Waveguide packaging
- Integrated optics packaging
- Vacuum feedthrough assemblies

### Customer Support:

OZ Optics offers consulting services for custom designed soldering systems, including a wide range of materials and supplies.

### Product Description:

OZ Optics hermetically sealable patchcords are designed for today's stringent requirements for component packaging. Utilizing bare fiber without costly metalization, and a proprietary sealing process, these patchcords feature a rugged hermetic feedthrough that can be soldered into an opto-electronic package using standard tin/lead solders. The hermetic seal tube is gold plated to promote good on-site sealing and corrosion resistance. These assemblies are capable of easily creating a seal that meets industry hermeticity requirements.

OZ Optics hermetically sealable patchcords are available with singlemode, multimode or polarization maintaining (PM) fibers. PM fibers offer a means to control polarization of optical signals throughout the system, thus controlling Polarization Dependant Losses (PDL) and Polarization Mode Dispersion (PMD). This control is crucial in developing high speed, 40 Gbs, 100 Gbs coherent detection systems.

In general, OZ Optics uses polarization maintaining fibers based on the PANDA fiber structure when building polarization maintaining components and patchcords. However OZ Optics can construct devices using other PM fiber structures. We do carry some alternative fiber types in stock, so please contact our sales department for availability. If necessary, we are willing to use customer supplied fibers to build devices.

As a new, unique service, OZ Optics now offers hermetic sealable patchcords with built-in optical taps for power monitoring. This allows one to tap a small percentage of light from the fiber inside the assembled component. This is ideal for applications such as monitoring the output power from a packaged laser diode assembly (See Figure 18, Page 4). It provides a more precise means of monitoring the signal intensity, as signals seen by the directional tap are not influenced by return losses from the fiber output, which otherwise would be seen in conventional laser diode modules. The main device and the monitor photodiode are packaged into a single housing, reducing both size and costs.

To the best of our knowledge, this is the only technology available to make this possible. A novel patent pending manufacturing process allows full automation, sharply reducing costs. For additional information, please refer to our data sheet titled *Inline Optical Taps and Monitors*.

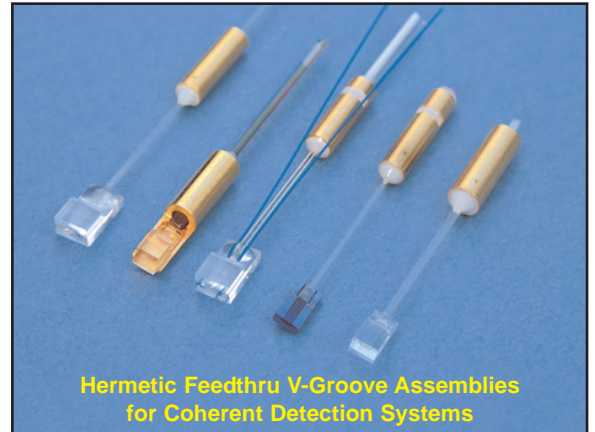

Hermetic Feedthru V-Groove Assemblies  
for Coherent Detection Systems

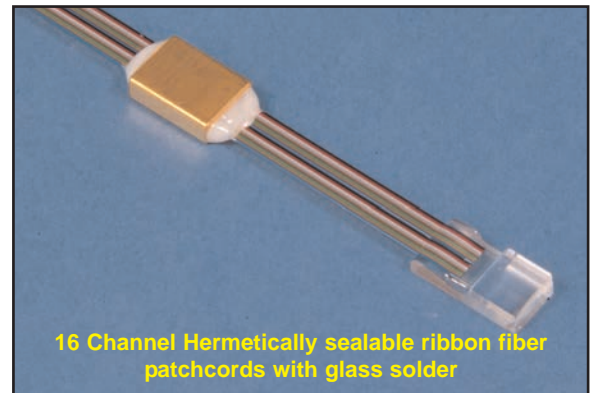

16 Channel Hermetically sealable ribbon fiber  
patchcords with glass solder



Single Channel  
Hermetically sealable patchcords with glass solder

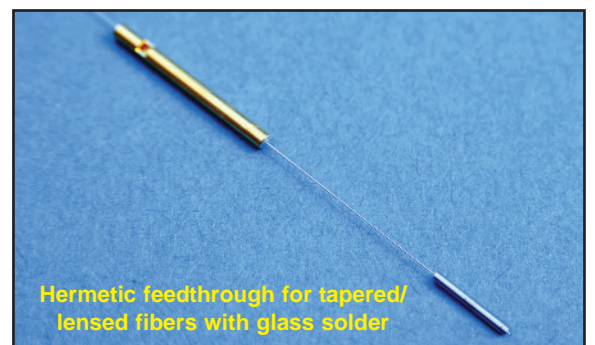

Hermetic feedthrough for tapered/  
lensed fibers with glass solder

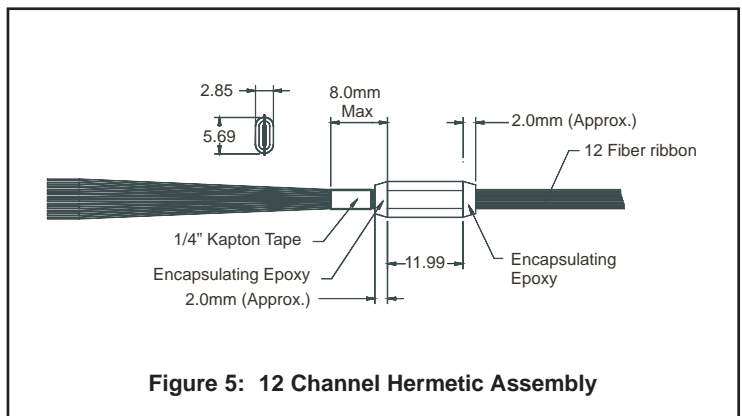
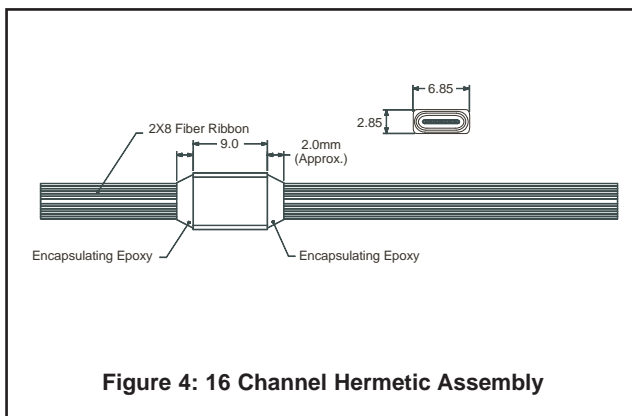
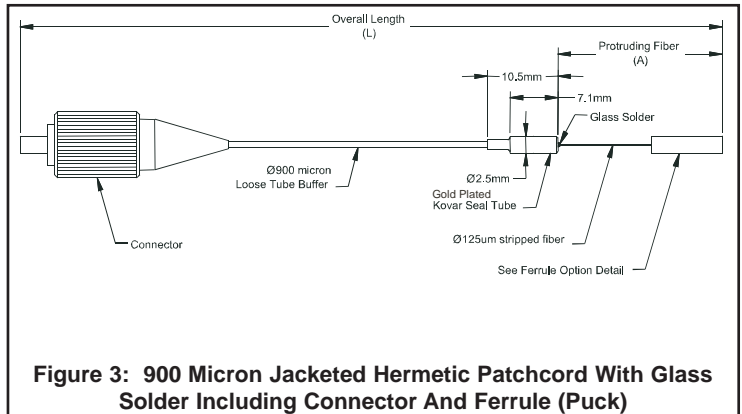
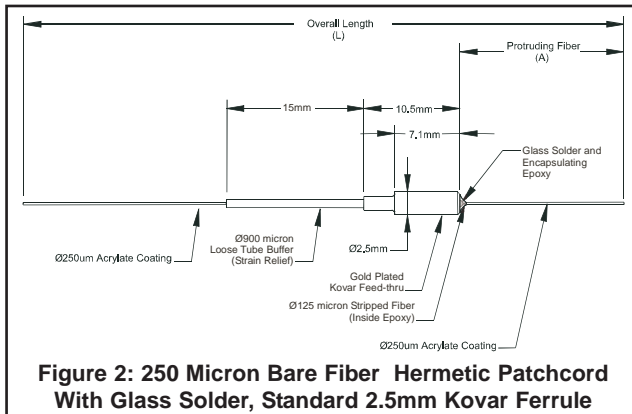
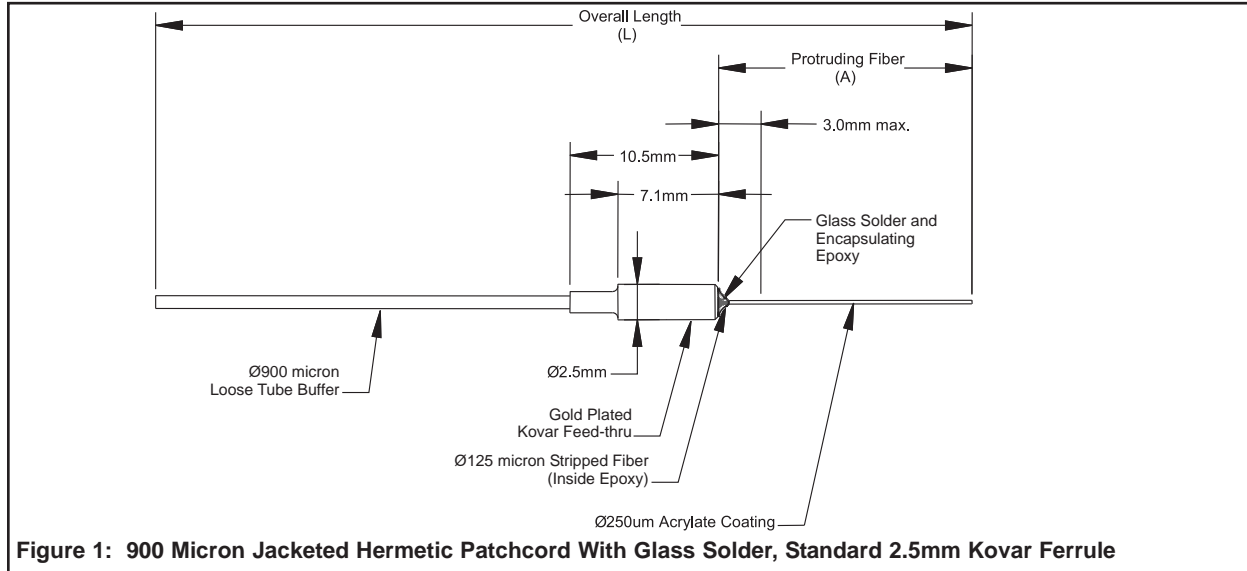
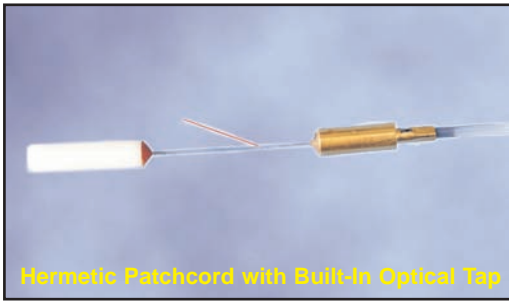

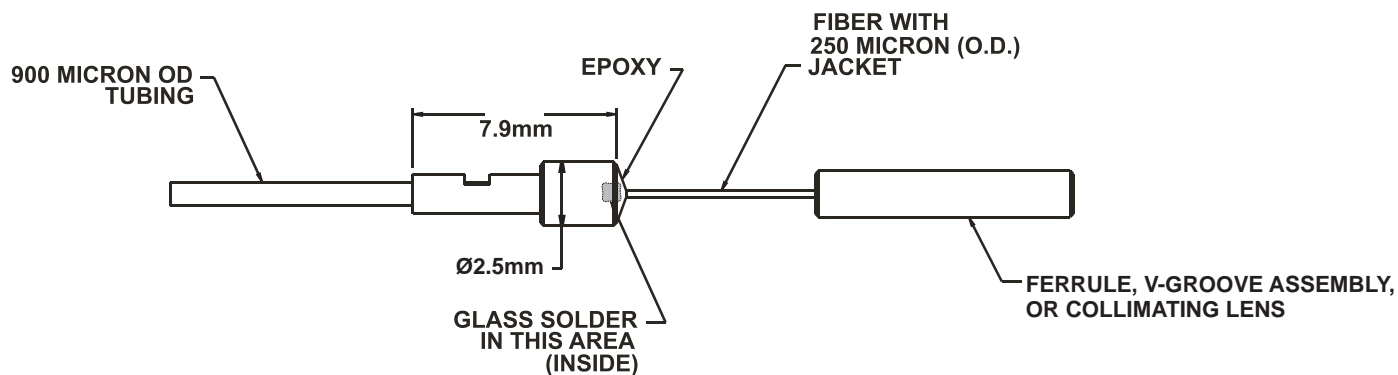

Figure 6: 900 Micron Jacketed Hermetic Patchcord With Glass Solder And 250 Micron Window Strip

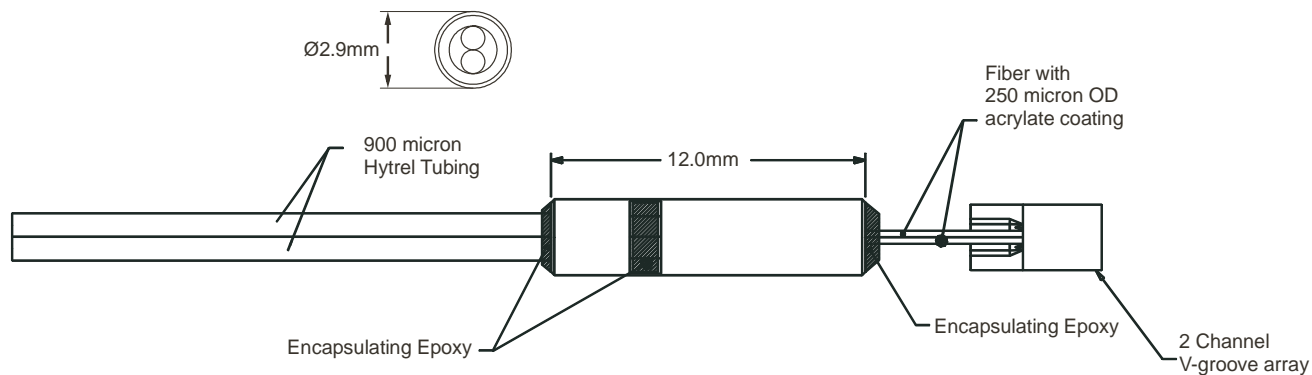

Figure 7: Two Channel V-Groove Assembly with Hermetic Patchcord

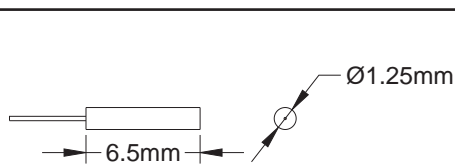

Figure 8: 1.25mm Ceramic Ferrule

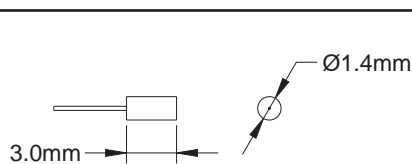

Figure 9: 1.4mm Ceramic Ferrule

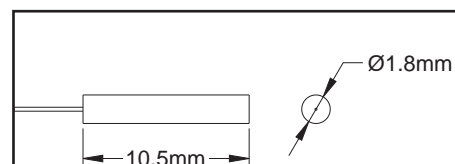

Figure 10: 1.8mm Ceramic Ferrule

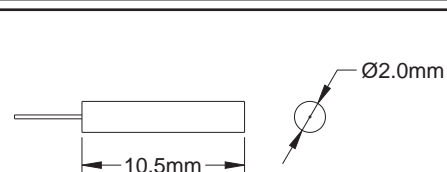

Figure 11: 2.0mm Ceramic Ferrule

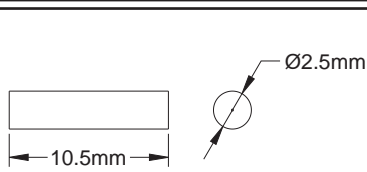

Figure 12: 2.5mm Ceramic Ferrule

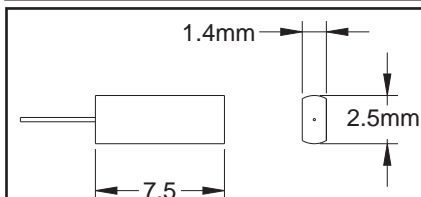

Figure 13: Rectangular Glass Ferrule

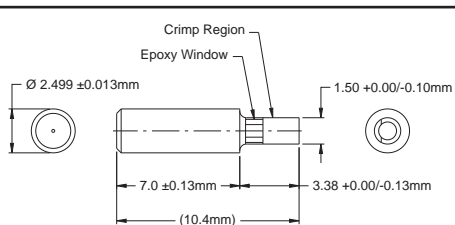

Figure 14: Standard 2.5mm OD Kovar Or Stainless Alloy Feedthrough

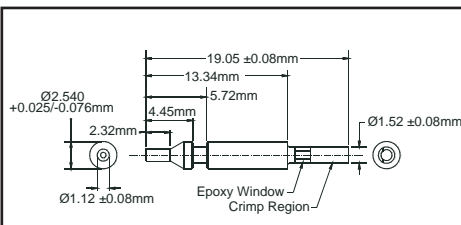

Figure 15: "Bullet Nose" 2.5mm OD Kovar Feedthrough

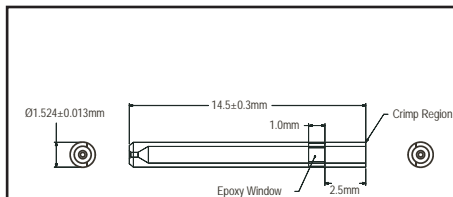

Figure 16: 1.53mm OD Kovar Feedthrough

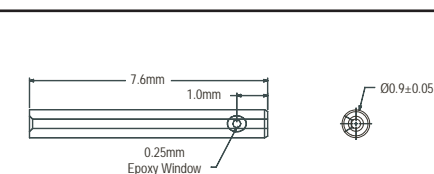

Figure 17: 0.9mm OD Kovar Feedthrough

### Ordering Information For Standard Parts:

Bar code	Part Number	Description
12593	HGPMJ-3A-1550-8/125-1-C1.4-14-1-2.5KO	1 meter long, 1mm OD jacketed 1550nm 8/125 Micron Polarization Maintaining fiber patchcord with an Angle FC/PC connector on one end, glass soldered tip on the other end. Protruding fiber length is 14mm, gold plated kovar OD is 2.5mm, 1.4mm OD x 3mm long ceramic ferrule on the end
11410	HGPMJ-X-1550-8/125-1-X-30-1.5-2.5KO	1.5 meter long, 1mm OD jacketed 1550nm 8/125 Micron Polarization Maintaining fiber patchcord with no connector on one end, glass soldered tip on the other end. Protruding fiber length is 30mm, gold plated kovar OD is 2.5mm, no ferrule or cleave on the end
12591	HGSMJ-3A-1300/1550-9/125-1-C1.4-14-1-2.5KO	1 meter long, 1mm OD jacketed 1300/1550nm 9/125 Micron Corning SMF-28 fiber patchcord with an Angle FC/PC connector on one end, glass soldered tip on the other end. Protruding fiber length is 14mm, gold plated kovar OD is 2.5mm, 1.4mm OD x 3mm long ceramic ferrule on the end
12186	HGSMJ-3A-1300/1550-9/125-1-X-267-1.27-2.5KO	1.27 meter long, 1mm OD jacketed 1300/1550nm 9/125 Micron Corning SMF-28 fiber patchcord with an Angle FC/PC connector on one end, glass soldered tip on the other end. Protruding fiber length is 267mm with a midstrip, gold plated kovar OD is 2.5mm, no ferrule or cleave on the end
10437	HGSMJ-3S-1300/1550-9/125-1-X-25-1.5-1.5KO	1.5 meter long, 1mm OD jacketed 1300/1550nm 9/125 Micron Corning SMF-28 fiber patchcord with a Super FC/PC connector on one end, glass soldered tip on the other end. Protruding fiber length is 25mm, gold plated kovar OD is 1.53mm, no ferrule or cleave on the end
11044	HGSMJ-SC-1300/1550-9/125-1-C2-10-1.5-2.5KO	1.5 meter long, 1mm OD jacketed 1300/1550nm 9/125 Micron Corning SMF-28 fiber patchcord with a SC connector on one end, glass soldered tip on the other end. Protruding fiber length is 10mm, gold plated kovar OD is 2.5mm, 2mm OD x 10.5mm long ceramic ferrule on the end
11174	HGSMJ-X-1300/1550-9/125-0.25-X-52-1-2.5KO	1 meter long, 0.25mm OD 1300/1550nm 9/125 Micron Corning SMF-28 fiber patchcord with no connector on one end, glass soldered tip on the other end. Protruding fiber length is 52mm, gold plated kovar OD is 2.5mm, no ferrule or cleave on the end
11551	HGSMJ-X-1300/1550-9/125-1-X-25-2-2.5KO	2 meter long, 1mm OD jacketed 1300/1550nm 9/125 Micron Corning SMF-28 fiber patchcord with no connector on one end, glass soldered tip on the other end. Protruding fiber length is 25mm, gold plated kovar OD is 2.5mm, no ferrule or cleave on the end
11409	HGSMJ-X-1550-9/125-1-X-30-1.5-2.5KO	1.5 meter long, 1mm OD jacketed 1300/1550nm 9/125 Micron Corning SMF-28 fiber patchcord with no connector on one end, glass soldered tip on the other end. Protruding fiber length is 30mm, gold plated kovar OD is 2.5mm, no ferrule or cleave on the end

### Ordering Examples for Standard Parts:

A customer needs to hermetically seal a fiber into a package. The fiber will be aligned using a 2mm ceramic ferrule, which needs to be approximately 10cm from the packaging port. The customer would also like the fiber to be 1.5 meters long with 900um jacketing and a SC connector on the opposite end.

Bar Code	Part Number	Description
11044	HGSMJ-SC-1300/1550-9/125-1-1-10-1.5-2.5KO	1.5 meter long, 1mm OD jacketed 1300/1550nm 9/125 Corning SMF-28 fiber patchcord with a SC connector on one end, glass soldered tip on the other end. Protruding fiber length is 10mm, gold plated kovar OD is 2.5mm, 2mm OD x 10.5mm long ceramic ferrule on the end

### Standard Product Specifications:

Helium Leak Rate	<10 ATM-cc/sec
Operating temperature	-40°C to +85°C
Pull Strength	1Kg minimum
Installation temperature	280°C max.
Polarization Extinction Ratio	>20dB, >25dB, or >30dB available for 1300 – 1625nm
Recommended installation solder	60% Tin / 40%Lead
Recommended installation temperature	185°C-200°C

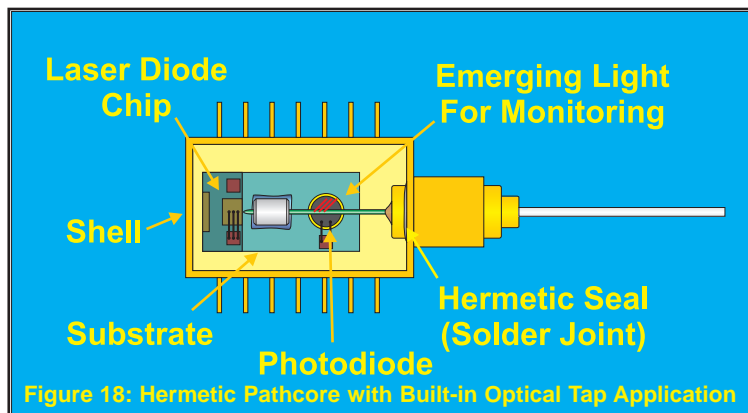

## Ordering Information For Custom Parts:

OZ Optics welcomes the opportunity to provide custom designed products to meet your application needs. As with most manufacturers, customized products do take additional effort so please expect some differences in the pricing compared to our standard parts list. In particular, we will need additional time to prepare a comprehensive quotation, and lead times will be longer than normal. In most cases non-recurring engineering (NRE) charges, lot charges, and a 25 piece minimum order will be necessary. These points will be carefully explained in your quotation, so your decision will be as well informed as possible. We strongly recommend buying our standard products.

## Questionnaire For Custom Parts:

1. What type of fiber do you require for your applications (singlemode, multimode, PM)?
2. What is your operating wavelength?
3. Does the fiber need to be cabled?
4. How long should the patchcord be?
5. How long would you like the fiber to protrude from the end of the seal tube?
6. Does the metalization need to cover the entire fiber? If not, how long do you need (from the end) to be without metalization?
7. Do you need a ferrule (or puck) on the end of the metalized fiber?
8. Do you need a connector on the other end?
9. What type or size of feedthrough best serves your needs?
10. Do you have any special requirements?

## HGFMJ-X-W- a/b-JD-YP-A-L-FT

**E** = Fiber Type  
 M = Multimode  
 S = Singlemode  
 P = Polarization Maintaining

**X** = Connector Code  
 3S = Super FC  
 3U = Ultra FC  
 3A = Angle FC  
 8 = ST  
 SC = Super SC  
 SCU = Ultra SC  
 SCA = Angle SC  
 MU = Super MU  
 LC = Super LC  
 LCA = Angle LC  
 X = No Connector  
 See Table 6 of the standard tables data sheet for other connectors.

**W** = Wavelength, in nanometers  
 1300/1550 for Corning SMF-28 Singlemode fiber

**a/b** = Fiber core/cladding  
 9/125 for Corning SMF-28 Singlemode fiber  
 6/125 for Corning Flexcore 1060 singlemode fiber  
 7/125 for 1300nm PANDA style PM fiber  
 8/125 for 1550nm PANDA style PM fiber

**JD** = Jacket Diameter  
 0.25 = 250 micron acrylate coating (singlemode bare fiber)  
 0.40 = 400 micron acrylate coating (PM bare fiber)  
 1 = 900µm Hytrel loose tube buffered fiber (standard)

**FT** = Hermetic feedthrough design (See figures 14-17)  
 2.5KO = Standard 2.5mm OD, gold plated kovar<sup>1</sup>  
 B2.5KO = "Bullet Nose" 2.5mm OD, gold plated kovar  
 2.5SA = Standard 2.5mm OD, gold plated stainless alloy  
 1.5KO = 1.53mm OD, gold plated kovar

**L** = Overall Length in meters

**A** = Protruding fiber length in millimeters

**P** = Angle polish for ferrules  
 A for 8 degree angle polish.  
 Leave blank for flat polish.  
 Contact OZ for custom angle polishes

**Y** = Ferrule Type (see figures 8-13)  
 C1.25 = Ceramic, 1.25mm dia.x7mm long  
 C1.4 = Ceramic, 1.4mm dia.x3mm long  
 C1.8 = Ceramic, 1.8mm dia.x10.5mm long  
 C2 = Ceramic, 2mm dia.x10.5mm long  
 C2.5 = Ceramic, 2.5mm dia.x10.5mm long  
 R = Rectangular glass, 1.4x2.5x7.5mm  
 0 = Flat (0 degree angle) cleave  
 8 = 8 degree angle cleave  
 X = Bare fiber. No ferrule or cleave

**Note 1:** Standard Tube

## Ordering Examples for Custom Parts

A customer needs to hermetically seal a PM 1550nm fiber into a package. The fiber will be aligned using a 1.25mm diameter ferrule, flat polished which needs to be approximately 25mm from the packaging port. The 1.53mm diameter feedthrough is needed. The customer would also like the fiber to be 2 meters long with 900µm jacketing and an angled FC/PC connector on the opposite end.

Part Number	Description
HGPMJ-3A-1550-8/125-1-C1.25A-25-2-1.5K0	2 meter long, 1mm OD jacketed 1550nm 8/125 Polarization Maintaining fiber patchcord with an Angle FC/PC connector on one end, glass soldered tip on the other end. Protruding fiber length is 25mm, gold plated kovar OD is 1.53mm, 1.25mm OD x 6.5mm long ceramic ferrule on the end, with an 8 degree angle polish.

## Frequently Asked Questions (FAQs):

**Q:** Is there a chance that I will break the hermetic seal on the fiber while soldering the assembly into my package?

**A:** The glass solder used to seal the fiber has a much higher melting point than the standard package solder (60/40 Tin Lead). Therefore if the proper soldering temperatures are used the seal will not be broken.

**Q:** Are the glass solder hermetic patchcords equivalent to the metal solder hermetic patchcords?

**A:** Yes, testing has shown that the glass solder meets the same requirements as the metal solder without having to metalize the fiber.

**Q:** What are the benefits of using glass solder over metal solder?

**A:** Glass solder provides greater flexibility in manufacturing customized products and eliminates adhesion problems systematic with metalization of fibers, as well as reducing the cost associated with metalization of fibers.

## Application Notes:

### Soldering Recommendations

#### Soldering Hermetic Feedthroughs Into Optical Packages

Because hermetic feedthroughs are installed using solders, care must be taken not to overheat the feedthrough or the fiber. Applying too much heat can potentially damage the hermetic seal, the jacketing, or the fiber itself. To minimize the likelihood of damage, we recommend the following precautions:

- 1) Ensure that all surfaces are properly cleaned and prepared:** To ensure a good solder joint, we recommend that the part the feedthrough is being installed into should be plated with at least 5 microns of nickel, followed by 1.3 microns of gold. All parts should be cleaned using isopropyl alcohol prior to soldering, to ensure that there are no organic residues on the parts.
- 2) Do not apply excessive heat while soldering:** The glass solder used to seal the fiber to the feedthrough has a melting temperature of over 340°C. Any soldering process used that heats the seal tube less than 280°C should work. 185°C to 200°C is recommended. There are also special low temperature solders, which can be used to provide a greater safety margin.
- 3) Minimize the area being heated:** The acrylate coatings used on standard fibers is designed for operating temperatures up to 85°C. Heating the fiber to temperatures significantly beyond this can damage the coating material. In addition, hytrel tubing, which is used as a protective loose tube buffer, has a softening temperature of 180C. Therefore care must be taken not to overheat the fiber.

To do so, one needs to use a soldering technique that only heats the package and the feedthrough at the point where the solder joint is being made. One option is to use a laser to apply heat at a precise point. Inductive heating is another useful, non-contact heating method. Eddy currents are generated locally by inducing voltage pulses in the feed-through tube. This in turn generates heat in the work pieces. Another approach is to use resistive heating. Current is applied across the area where the solder joint is being made. The current heats the pieces. The heat is concentrated in the area of greatest current. The current, temperature and time can all be precisely controlled. No matter what method is used, the time taken to actually make the solder joint should be kept to a minimum, ideally less than 10 seconds. Otherwise the surrounding parts will begin to be heated, including the fiber and jacketing.

- 4) Minimize the use of fluxes:** Although fluxes do improve the wetting of standard solders to metal surfaces, they are also a potential source of contamination. To best control the amount of flux being used, OZ Optics recommends using solder performs, with the flux already in the core of the perform. This ensures that only a controlled amount is being used, and that it is only applied to the region being soldered. Any excess flux should be wiped away immediately after the solder has cooled back to room temperature (typically less than one minute).

#### Proper Storage and Handling of Stripped or Glass Soldered Fibers:

Given that the protective acrylate coating is partially removed from a fiber when it is stripped prior to glass soldering, certain precautions should be taken to ensure that the fiber will remain as strong as possible. This includes controlling the humidity, minimizing tensile stress, and minimizing handling of the bare glass.

**Humidity:** Humidity is not an issue unless the fiber is under some tensile stress. If there is stress, water from the air will find its way into the microscopic flaws in the glass and break the silica bonds, potentially leading to a fiber break years down the road. If there is no tensile stress, then this mechanism doesn't work. If the fiber will be placed under stress during subsequent processing steps and the fiber surface is either contaminated or has an effectively high moisture surface content from the air, then one can potentially cause a failure. It is good practice to store bare fiber (i.e. stripped or glass soldered fiber products) in a dry, controlled atmosphere or in nitrogen atmosphere.

**Handling:** With respect to mechanical reliability, once the protective coating has been removed, the bare glass is vulnerable to damage with any subsequent handling. Thus your production process should eliminate any handling of the bare glass on the stripped section. Also, one should design the product to minimize unnecessary contact with the bare glass.

**Fatigue resistance and maintaining fiber reliability:** In general do not subject the fiber to stress higher than 50% of the proof stress for longer than 1 second, or 1/3 of proof test for longer than 4hrs. (i.e. 100kps = 50kpsi for 1 second). Also for fiber patchcords, do not bend the fiber too tightly. For 100kpsi fiber do not bend any tighter than a 13mm bend radius. For 200kpsi do not bend the fiber any tighter than a 6.5mm bend radius.

**Cleaning:** Use Isopropyl Alcohol (IPA) with a lint free open mesh cloth. Perform a single wipe only. Never use Acetone to clean.

By keeping these handling practices in mind, one should be able to routinely install hermetic feedthroughs using glass solders into your system with high yields and reliability.

#### Ribbon Fiber Hermetic Patchcords

There have been several issues in trying to hermetically seal more than one fiber at a time into a package. The traditional method of using a metalized fiber construction to accomplish this task has demonstrated some inherent manufacturability problems including the cost of individually metalizing fibers and then handling them to create a consistent seal, difficulty in getting even metalization between ribbon fibers, and adhesion problems with the metalized fibers including flaking, blisters and cracking of the metalization. The OZ Optics hermetic patchcords with glass solder for ribbon fibers eliminates these issues by providing a fully assembled hermetic seal directly onto the bare glass. The glass solder material is processed in such a manner that a consistent seal is created between the glass fibers in a ribbon and a hermetic seal tube. The seal tube can then be hermetically sealed into your package using industry standard sealing solders, using standard temperatures and techniques. These assemblies relieve the concern about damaging the fibers during the sealing process, having to handle many individual fibers at once, and having inconsistent hermetic sealing around the fibers. The hermetic patchcords with glass solder for ribbon fiber can also be provided with a V-Groove array assembly, ready to attach and package.