

Distributor

 info@amstechnologies.com
 www.amstechnologies-webshop.com
Contact us 

ITEM	Material	DESCRIPTION
1 3420003	SUS 304L	SMA CONNECTORS
2 3420015	SUS 304L	HOUSING
3 LDA130	D-ZK3M	MOLDED ASPHERE

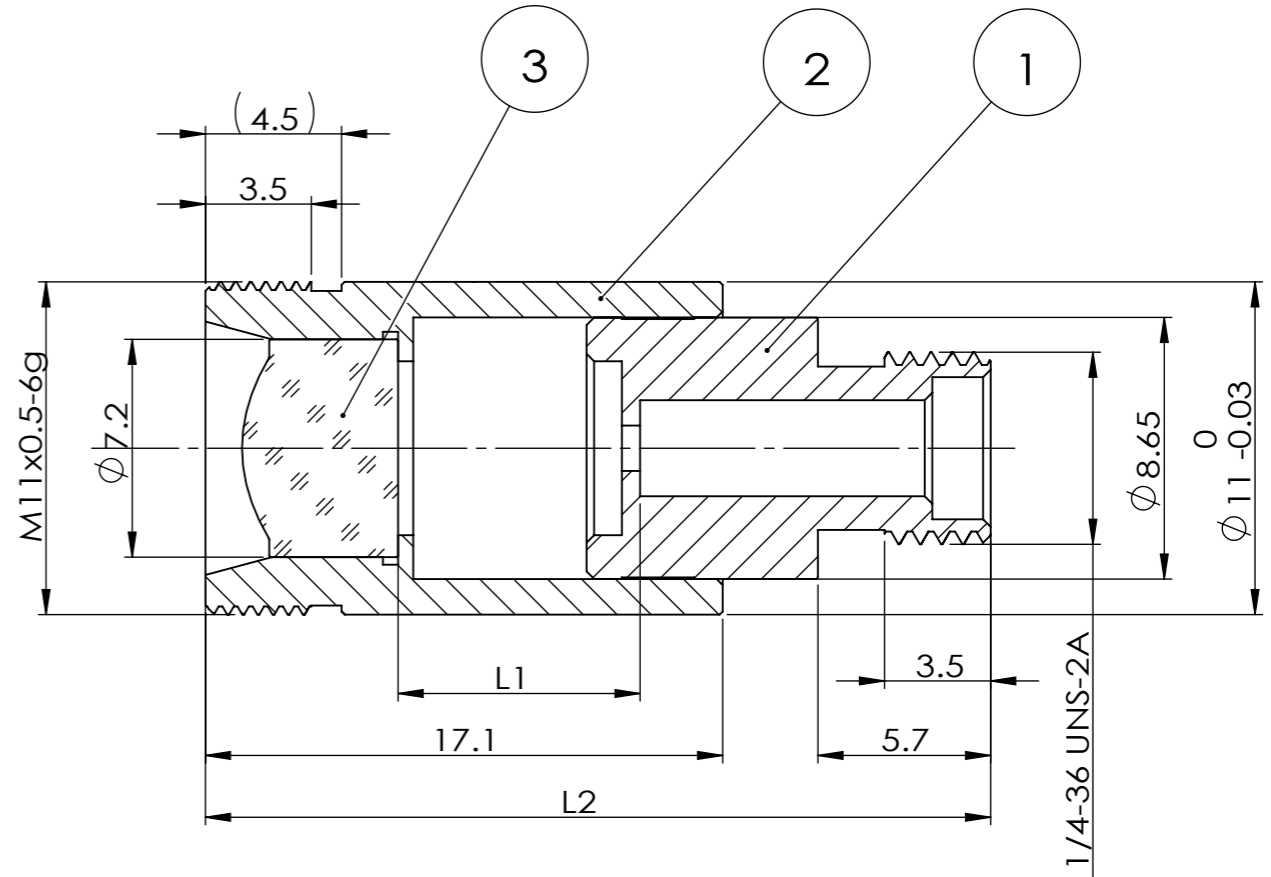

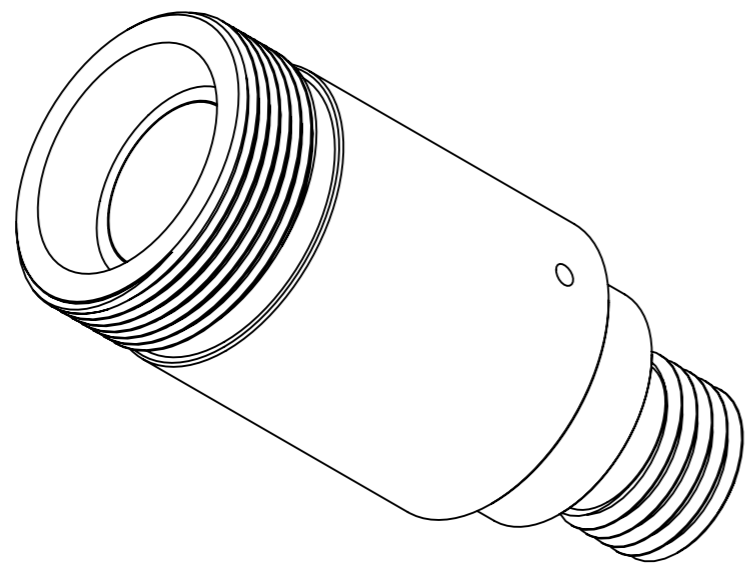

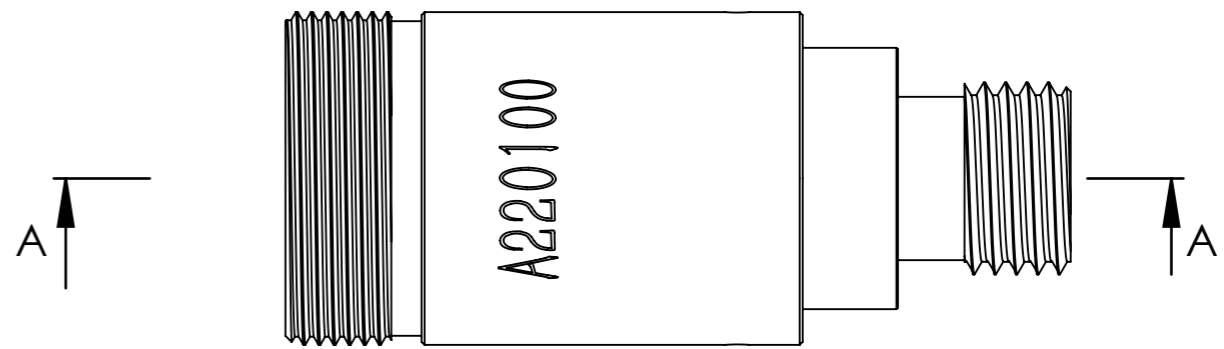
SECTION A-A

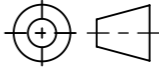

PART NUMBER	λ	ALIGNMENT FIBER	L1 (mm)	L2 ± 0.25 (mm)
FDA13030405	405nm	C405	7.53	25.69
FDA13030532	532nm	460HP	7.74	25.90
FDA13030633	633nm	SM600	7.82	25.98
FDA13030780	780nm	780HP	7.90	26.06
FDA13031064	1064nm	HI 1060	7.99	26.15
FDA13031310	1310nm	SMF-28e	8.05	26.21
FDA13031550	1550nm	SMF-28e	8.11	26.27

DO NOT SCALE DRAWING.

DRAWING PROJECTION. 

 **GH Optics (Jiangsu) Co., Ltd.**
 www.ghoptics.cn

TITLE: Connectorized Collimators with SMA

DWG NO. **FDA13030532**

NAME	DATE
DRAWN	
CHK'D	
APPV'D	

UNIT: mm SIZE: A3 SHEET 1 OF 1 REV. A