

SPECIFICATION OF THERMOELECTRIC COOLING ASSEMBLY 120-12-AA

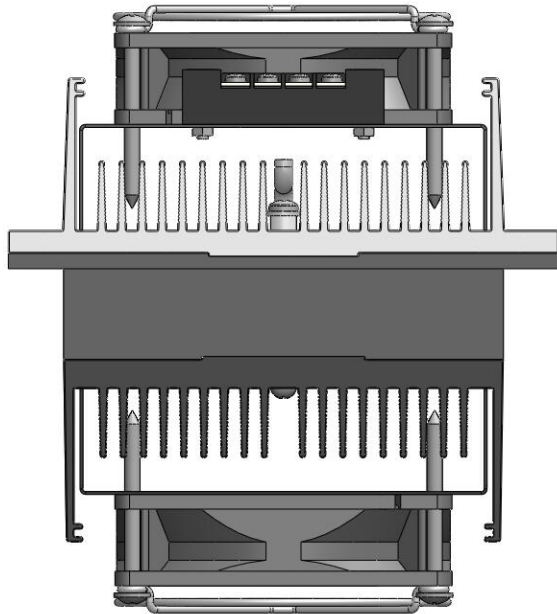
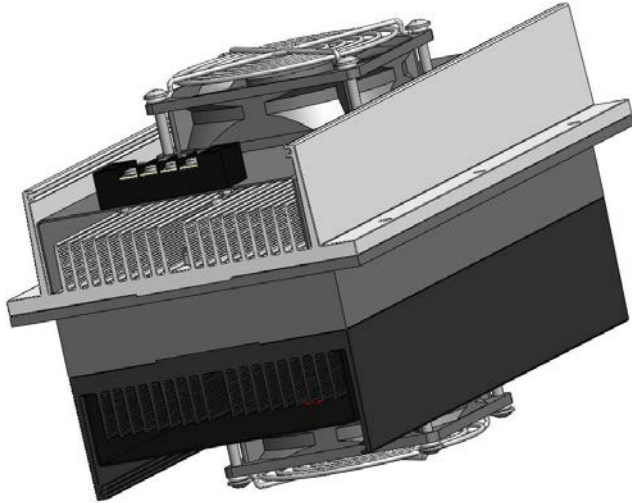

<i>Thermoelectric parameters</i>	<i>Unit</i>	<i>Value</i>
Operating voltage (U)	Volts	12
Operating current (I)	Amps	15.2
Electric power (P)	Watts	182
Operating cooling power (Qc)	Watts	60
Max. cooling power	Watts	90
Tolerance	%	±10

<i>Operation parameters</i>	<i>Unit</i>	<i>Value</i>
Working temperature range	°C	-30 ÷ +70
Noise level	dBA	36
Net weight	kg	3.7

Distributor



amSTECHNOLOGIES
where technologies meet solutions

info@amstechnologies.com
www.amstechnologies-webshop.com

Contact us 

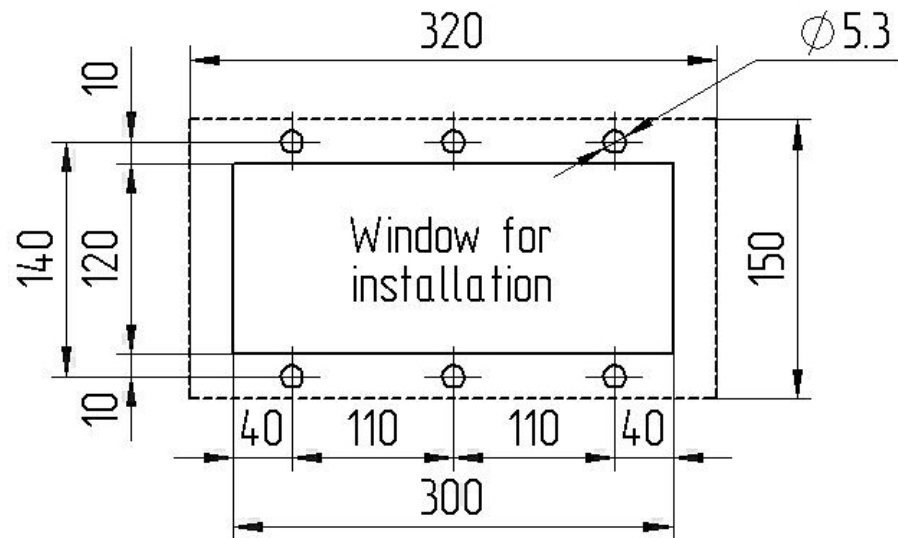
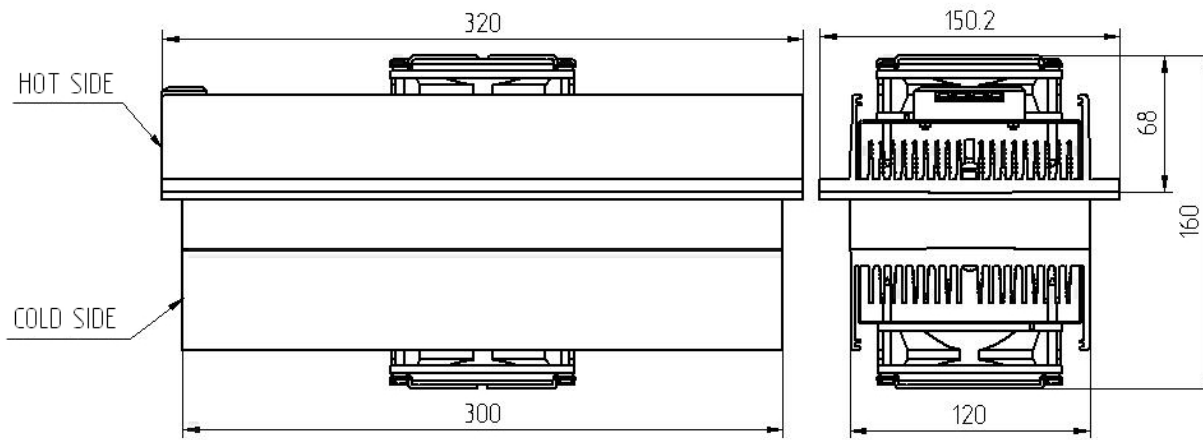

Qc, Watts

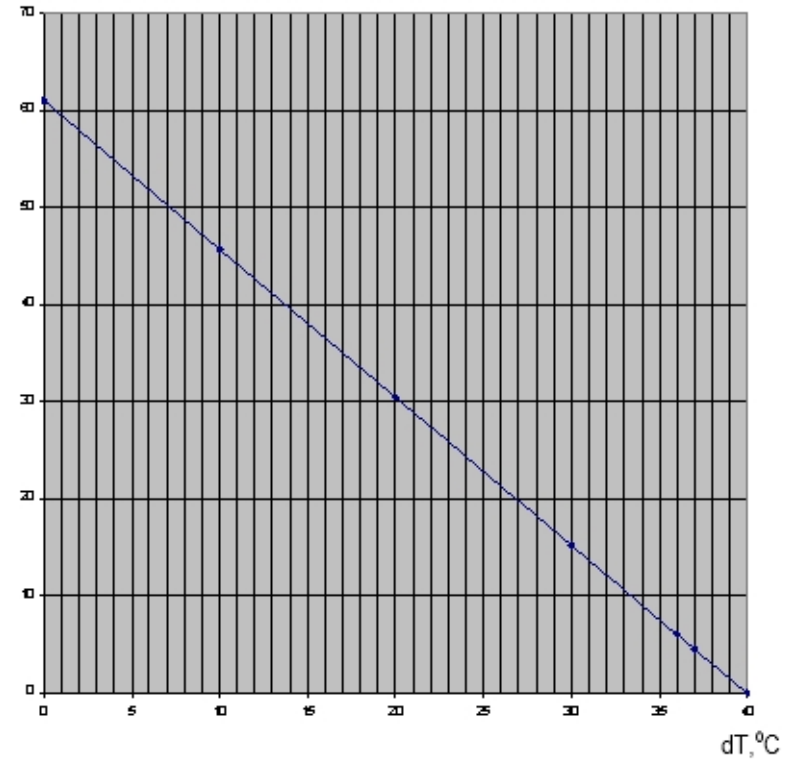

Distributor



amstechnologies
where technologies meet solutions

info@amstechnologies.com
www.amstechnologies-webshop.com

Contact us 