

PIR Detector

Infrared Sensing Solutions

PYQ 2498 / 3766

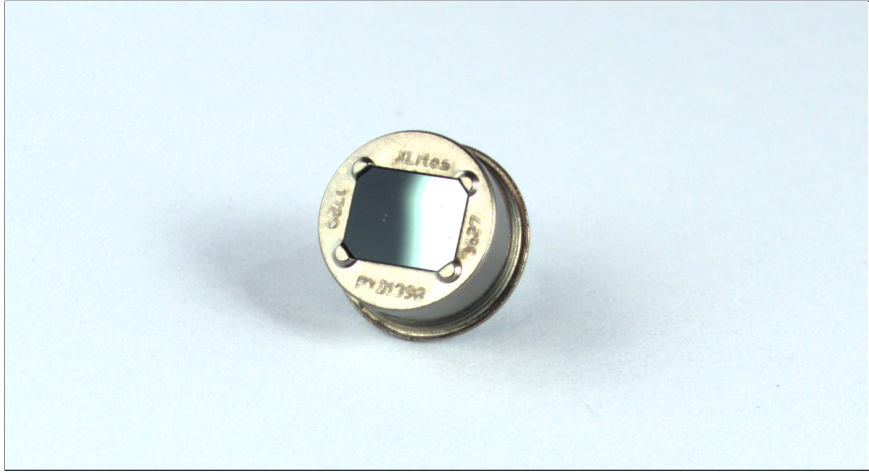

Differential Channel Quad Element Pyro

The PYQ 2498 is a two channel, serial opposed format, four elements detector based on pyroceramic. The element pairs are arranged parallel to each other. The arrangement allows for differential signal analysis in a horizontal mounting application.



Product Specification

Features

- TO-5 metal housing for EMI shielding
- High responsivity ceramic pyroelectric elements
- Quad detector with $1.0 \times 1.4 \text{ mm}^2$ elements
- 110° field-of-view
- Integrated FET in source follower configuration
- Intergrated EMI filtering stage

Applications

- Long distance motion detection (with lens)
- Energy saving applications
- Intrusion alarms
- Wall mounting applications
- Pet immunity solutions (with proper lens)

Distributor



AZPECT
part of

amSTECHNOLOGIES

where technologies meet solutions

nordics@amstechnologies.com
azpect.amstechnologies.com

Contact us



Contents

1 Physical Characteristics	3
1.1 Pyro-Electric Elements	4
1.2 Optical Properties	5
1.3 Filter Properties	6
2 Electrical Characteristics	7
2.1 Absolute Maximum Ratings	7
2.2 Electrical Data	7
3 Handling, Operation and Precautions	8
3.1 Handling	8
3.2 Operation	8
4 Quality and Statements	9
5 Packaging	10

1 Physical Characteristics

Table 1: Summary of physical characteristics. Parameters and data refer to an ambient temperature of $25 \pm 3^\circ\text{C}$.

Parameter	Symbol	Min	Typ	Max	Unit	Remarks/Conditions
Housing			TO-5			see fig. 1
Field of View	FOV		110		°	see sec. 1.2
Element Size			1.0 × 1.4		mm	see fig. 1
Spacing			0.8		mm	see fig. 1
Responsivity	R	3.5	4.5		kVW^{-1}	see sec. 1.1
Match	$(R_A - R_B)/R_A$			15	%	see sec. 1.1
Noise			30	75	μV_{pp}	see sec. 1.1
IR-Filter			Standard			see sec. 1.3

Figure 1: Dimensions and Connections. Explanations follow in this document.

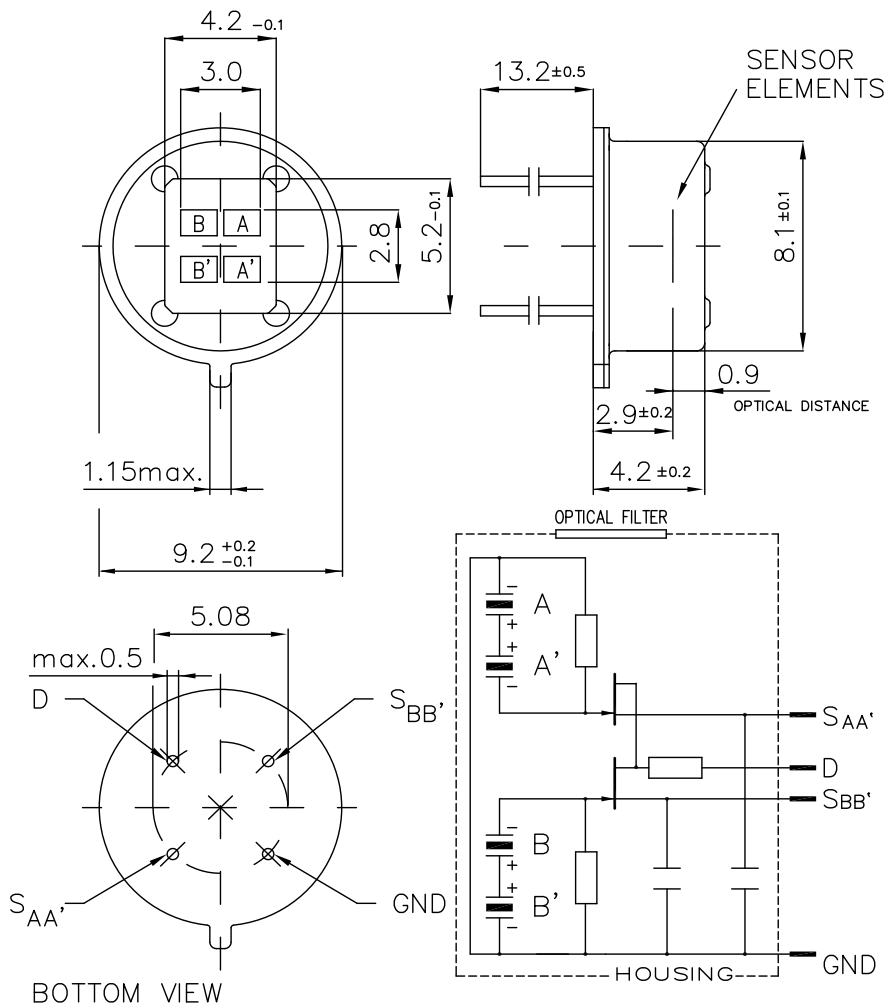

1.1 Pyro-Electric Elements

The element configuration is shown in figure 1. It features a quad element configuration in a serial opposed format. Its typical application is long distance, wall mounted, differential signal motion detection .

Figure 2: Test set up for the measurement of responsivity and match.

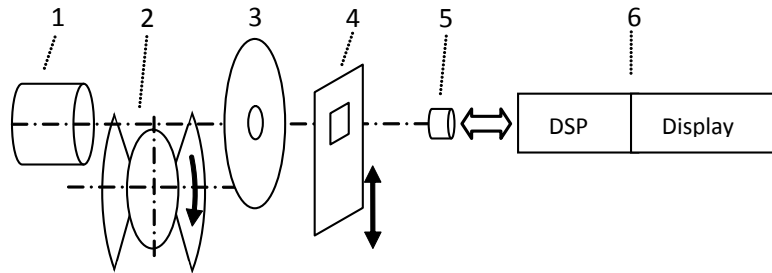
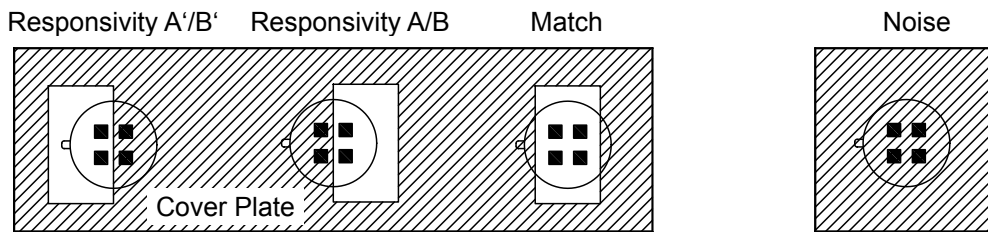

Figure 3: Masking of elements to test the electrical parameters.



The typical set-up for the measurement of responsivity and match is illustrated in figure 2. The black body (BB) radiator (1) is set to 373 K (100 °C). The signal is modulated by a rotating chopper (2). An aperture (3) is used to adjust the radiation flux. The cover plate (4) is masking the elements as shown in figure 3. The sensor (5) is interfaced to a signal processing chain (6). To measure noise, a bandpass filter in the range of 0.4 Hz to 10 Hz is applied.

Responsivity (*R*) and match are measured at a modulation frequency of 1 Hz.

The match is defined by

$$\frac{\text{Match}}{R} \times 100 \tag{1}$$

Noise is measured shut from infra-red energy. The measurement is performed after a settling time of 10 min at an ambient temperature of 25 °C ± 3 °C. Noise is monitored for the duration of 600 s .

1.2 Optical Properties

Figure 4: Illustration for the definition of the horizontal field of view (FOV).

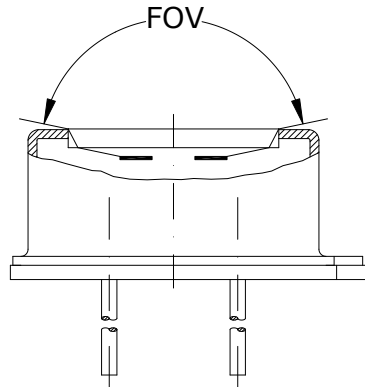

The horizontal field of view (FOV) as drawn to figure 4 is given as the geometrically unobstructed light path to both elements. The FOV of 110° is given for the optical light acceptance with the full so-called common mode suppression.

The optical distance as it is given in figure 1 represents the effective focal plane for the application specific optics. The optical distance is shorter than the geometrical due to refraction of light in the filter.

Distributor



amstechnologies
where technologies meet solutions



AZPECT
part of

nordics@amstechnologies.com
azpect.amstechnologies.com

Contact us 

1.3 Filter Properties

Table 2: Filter properties

Parameter	Symbol	Min	Typ	Max	Unit	Remarks/Conditions
Average Filter Transmittance	T_A	77			%	$7.5 \mu\text{m} < \lambda < 13.5 \mu\text{m}$
Average Filter Transmittance	T_A			0.5	%	$\lambda < 5 \mu\text{m}$
Cut-on Wavelength	$\lambda(5\%)$	5.2	5.5	5.8	μm	at 25°C

Figure 5: Filter transmittance, typical curve

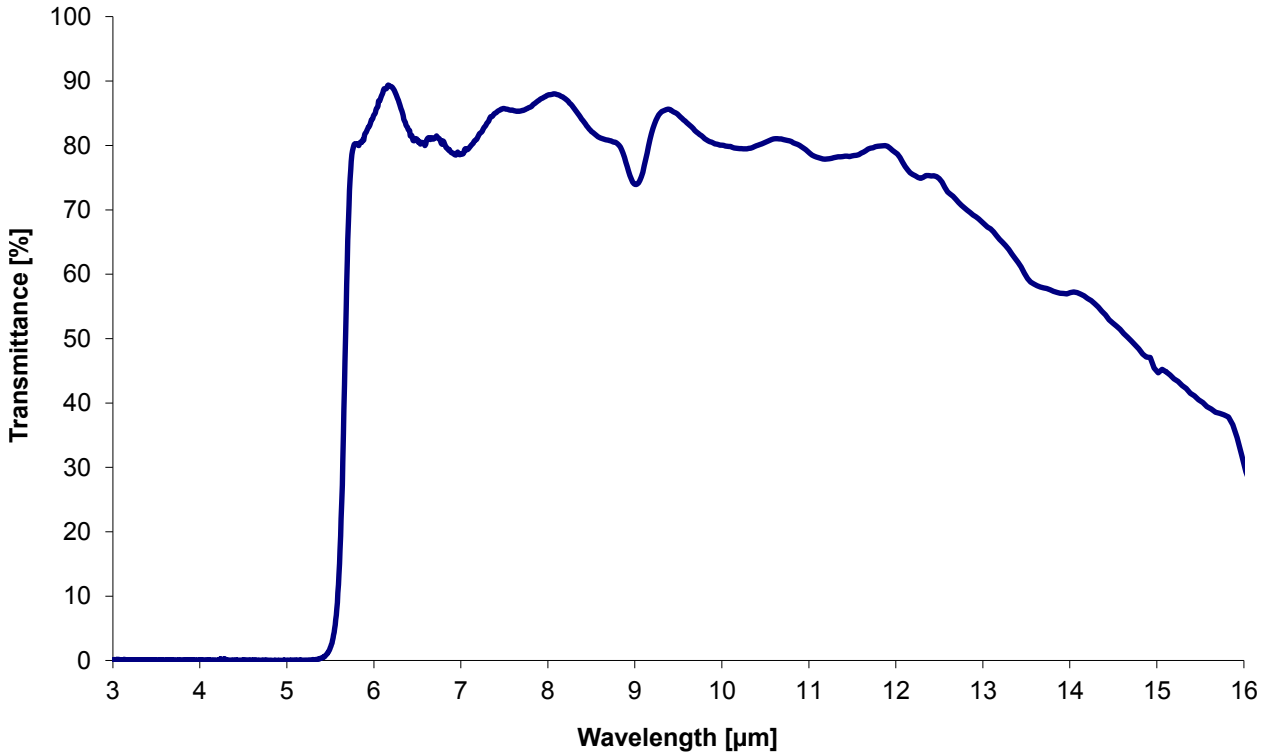

2 Electrical Characteristics

2.1 Absolute Maximum Ratings

Table 3: Absolute Maximum Ratings. Data applicable to operation at free-air temperature range.

Parameter	Symbol	Min	Typ	Max	Unit	Remarks/Conditions
Operating Voltage	V_{DD}			12	V	
Storage Temperature		-40		85	°C	< 60 % r.H.
Operating Temperature		-40		70	°C	

Stresses beyond the limits listed in table 3 may cause permanent damage to the device. Exposure to absolute maximum ratings for long time may affect the device reliability and may lead to deterioration of any parameter.

2.2 Electrical Data

Table 4: Operating Voltages at the connections to the internal FET.

Parameter	Symbol	Min	Typ	Max	Unit	Remarks/Conditions
Operating Voltage	V_{DD}	2		12	V	
Source/Offset Voltage	V_s	0.2		1.5	V	
Drain-Source Voltage	V_{DS}	0.5			V	

The sensing elements are connected to a build-in FET in source follower circuit (see figure 1). It is recommended to use a load resistor of 47 k Ω . Unless specified differently all data and specifications refer to 25 °C \pm 3 °C and $V_{DD} = 11$ V. Parameters will vary when operating at different temperatures.

3 Handling, Operation and Precautions

3.1 Handling

Shelf Life The product can be stored for 12 months before usage at -10°C to 40°C (<60 % r.H. at 40°C non condensing).

Storage Avoid storage under high humidity and/or high ambient temperature environments.

ESD Handle the detectors as ESD sensitive devices and protect them from electrostatic discharges. Working areas should be conductive and grounded. When handling detectors, operators shall be grounded.

Mechanical Avoid mechanical stress on the housing and especially on the leads. Be careful when cutting or bending leads to avoid damage. Do not bend leads less than 5 mm from their base. Do not drop detectors on the floor.

Cleanliness Avoid touching the detector window. To clean windows, use only ethyl alcohol with a cotton swab when necessary. Do not expose detectors to aggressive detergents such as Freon, trichloroethylene, etc.

Soldering Conditions For the soldering of the detectors within PCBs, the typically applied and recommended process is wave soldering. The recommended soldering temperature shall not exceed 285°C with a maximum exposure time of 5 seconds. During the automatic wave solder process we strongly advise to restrict preheating when the detector is directly exposed to the radiation of such heaters. In this case, the detector should be protected from the heat.

Manual soldering is also possible when maintaining similar temperature profiles.

Re-flow soldering is not possible due to the high temperature profiles of the process.

Temperatures higher than recommended may affect its performance. Any soldering process should be qualified to avoid damage to the sensor.

3.2 Operation

Humidity The operation below the dew point may affect the performance.

Temperature Strong temperature gradients above 1 K min^{-1} may affect the sensor's performance. Before taking a reading, during testing, and / or operation the unit has to become thermally stable (due to its nature as a thermal detector and the high sensitivity of the device).

All data is specified at room temperature. When operating at other temperatures within the specified operating range, parameters may vary. The detectors might operate outside the quoted range but may have degraded performance.

4 Quality and Statements

Quality Excelitas Technologies is a ISO 9001:2015 certified manufacturer with established SPC and TQM. Detector out-going inspections include the parameters responsivity, match, offset, noise, gross leak. Due to high level mass production, individual data is not stored.

Excelitas Technologies is certified for it's Environmental Management System according to ISO 14001:2015 and for the Occupational Safety and Health Management System according to OHSAS 18001: 2007.

All devices employing PCB assemblies are manufactured according IPC-A-610 class 2 guidelines.

The infra-red detection product line is certified for ANSI/ESD S.20.20:2014.

Package This IR-detector is sealed to pass a He-leakage test with maximum leak rate of 1×10^{-8} mbar l s⁻¹.

Tracability The marking of the detector includes the principal type, a 4 digit number that represents the Excelitas identification number. A 4 digit date code is provided in addition to that. It consists of the production year and week. The marking is printed on the top or side of the detector.

Safety Modern high-tech materials are applied in the production of our pyro-electric detectors. Some of these materials are sensitive to high temperature exposure or to specific forms of stress. Our parts are compliant with environmental regulations such as RoHS 2011/65/EU. For details please contact our local representatives. We recommend to always check your local regulations. Disposal shall only be carried out in accordance with the latest legislation and directives. In Europe, WEEE directives must be followed.

The leads of these detectors have been pre-tinned with lead free tin process and may be applied through lead-free solder processes. As such the detectors will enable the design of RoHS compliant products.

Liability Policy The contents of this document are subject to change. The details of this document are valid by the specified revision date. Excelitas reserves the right to change at any time total or part of the content of this specifications without individual notification. Customers should consult with Excelitas Technologies' representatives to ensure updated specifications before ordering.

Customers considering the use of Excelitas Technologies devices in applications where failure may cause personal injury or property damage, or where extremely high levels of reliability are demanded, are requested to discuss their concerns with Excelitas Technologies representatives before such use.

The Company's responsibility for damages will be limited to the repair or replacement of defective product. As with any semiconductor device, thermopile sensors or modules have a certain inherent rate of failure. To protect against injury, damage or loss from such failures, customers are advised to incorporate appropriate safety design measures into their product.

5 Packaging

The Excelitas Technologies tube packaging system protects the product from mechanical and electrical damage and is designed for manual unloading. Figure 6 shows the basic outline.

The system consists of tubes which are protected against ESD (5). The devices are loaded sequentially and fixed with stoppers (4). Up to 50 parts are filled into one tube. In total up to 20 tubes are placed in one paper box (3) filled with protective sponges (8,9,10).

Information labels, ESD labels and bar-code Labels (7) are placed on the box. The label (7) contains the following Information:

- Producer = Excelitas Technologies
- Origin
- Product Name
- Full BAU (unique identification) number
- Batch Number
- Packaging Date

Figure 6: Information about the packaging of sensors.

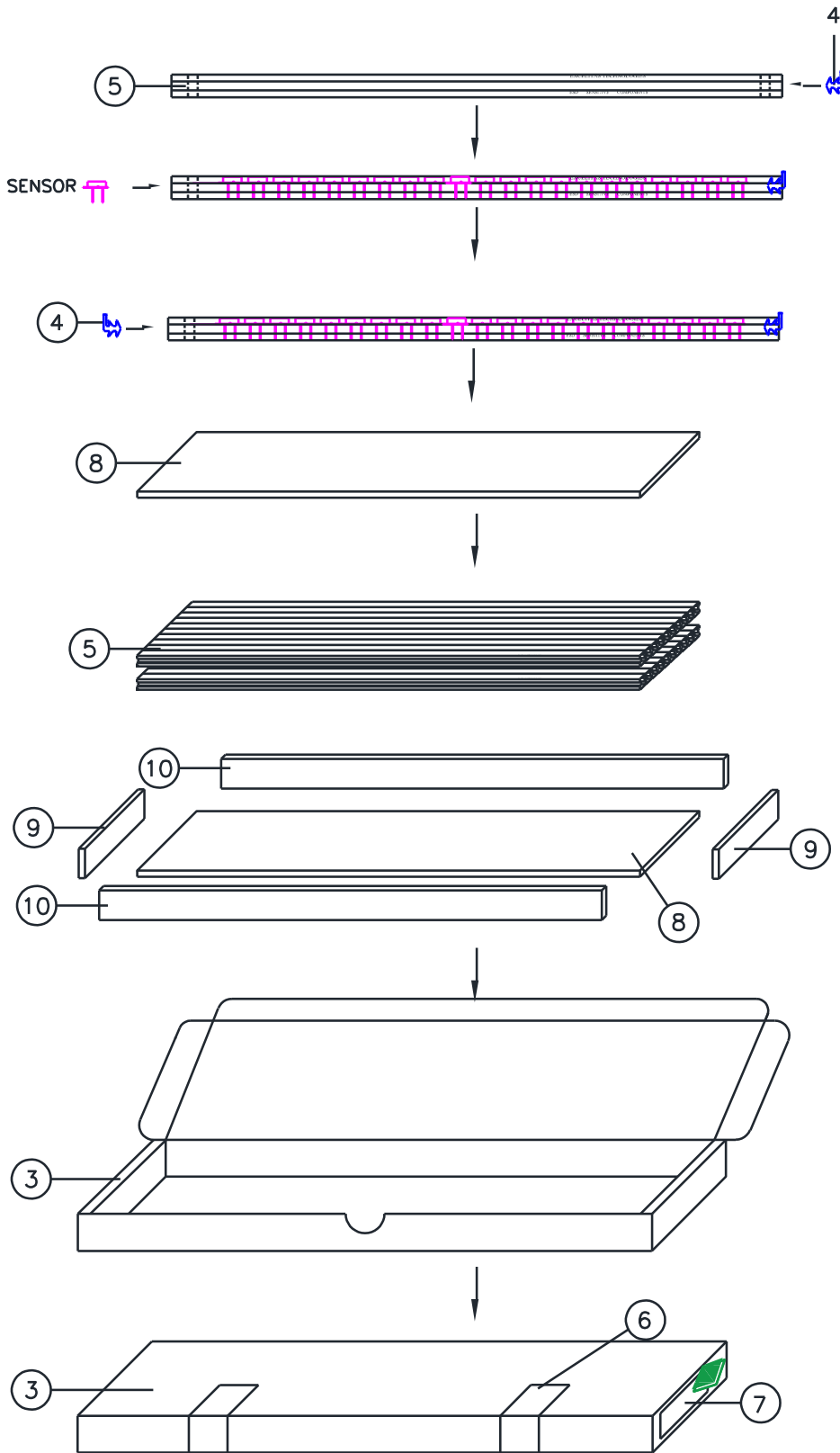

Distributor



AZPECT
part of
amSTECHNOLOGIES
where technologies meet solutions

nordics@amstechnologies.com
azpect.amstechnologies.com

Contact us 