

Distributor  
  
 info@amstechnologies.com  
 www.amstechnologies-webshop.com  
**Contact us**

ITEM	Material	DESCRIPTION
1 3420003	SUS 304L	SMA CONNECTORS
2 3420014	SUS 304L	HOUSING
3 LDA520	D-ZK3M	MOLDED ASPHERE

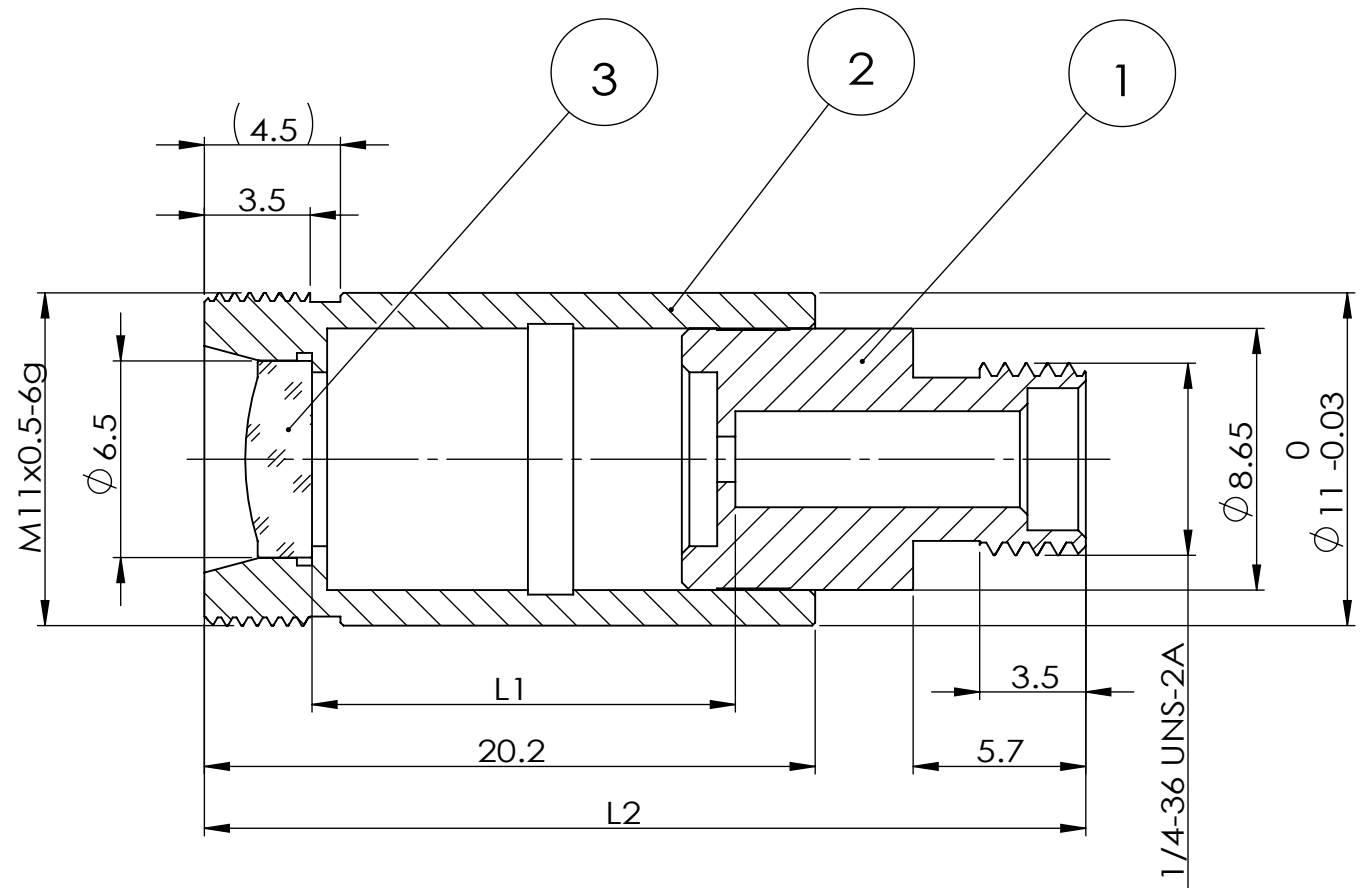

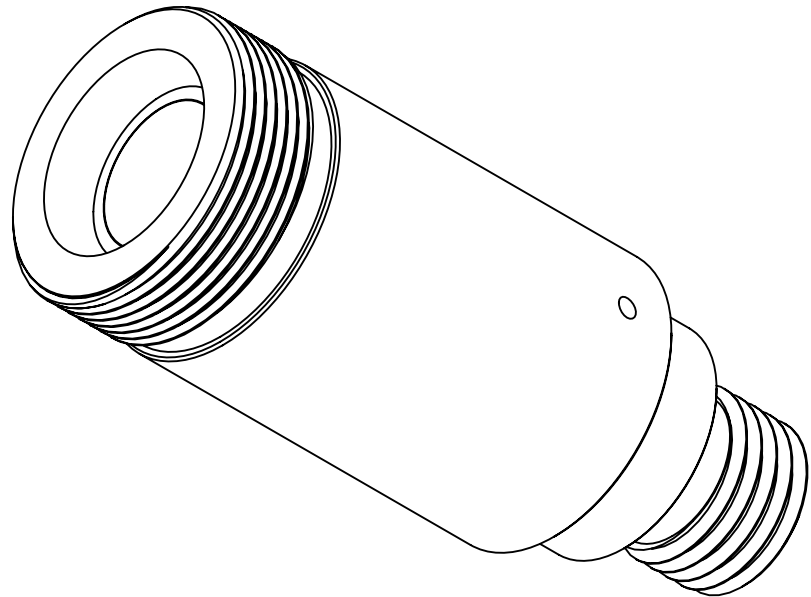

SECTION A-A

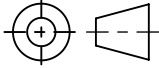

PART NUMBER	$\lambda$	ALIGNMENT FIBER	L1 (mm)	L2 $\pm 0.25$ (mm)
FDA52030405	405nm	C405	13.33	29.03
FDA52030532	532nm	460HP	13.64	29.34
FDA52030633	633nm	SM600	13.77	29.47
FDA52030780	780nm	780HP	13.89	29.59
FDA52031064	1064nm	HI 1060	14.03	29.73
FDA52031310	1310nm	SMF-28e	14.12	29.82
FDA52031550	1550nm	SMF-28e	14.21	29.91

DO NOT SCALE DRAWING.

DRAWING PROJECTION. 

 **GH Optics (Jiangsu) Co., Ltd.**  
www.ghoptics.cn

TITLE: Connectorized Collimators with SMA

DWG NO. FDA52031064

NAME	DATE
DRAWN	
CHK'D	
APPV'D	

UNIT: mm    SIZE: A3    SHEET 1 OF 1    REV. A