

HIGH POWER / HIGH TEMPERATURE FIBER OPTIC PATCHCORDS

USA PATENT #: 7431513

Features:

- Unique connector design minimizes thermal damage
- Patented connector designs for precise fiber to fiber coupling
- Able to withstand temperatures up to 500°C
- Compatible with SMA905 and FC connectors
- Different fiber endface finishes available for higher power applications
- Stainless steel armored cabling for maximum safety
- High power anti-reflection coatings available
- Multimode, singlemode, and polarization maintaining fiber types
- Operating wavelengths from 200 nm to 2000 nm
- Two micron to 1500 micron diameter core sizes
- Low and high numerical aperture fibers
- Fiber endcaps with ± 25 micron thickness tolerance
- Versions with cooling fins and cladding mode stripping available for very high power

Applications:

- Laser marking, cutting and welding
- Materials processing
- High power spectroscopy
- Non-linear optics
- Laser surgery (including cosmetic surgery, eye surgery, tattoo removal)
- Light detection and ranging (LIDAR)

Product Description:

OZ Optics produces fiber optic patchcords specifically for high power applications. These patchcords feature special high power fibers, carefully prepared fiber endfaces, and specially designed fiber optic connectors to ensure maximum power handling for your application.

In standard connectors the fibers are glued into place, and the fiber is polished flush with the connector ferrule tip (See figure 1A). When used with high power lasers, heat generated at the tip of the fiber causes the surrounding epoxy to break down and give off gases. These gases, in turn, burn onto the tip of the fiber, causing catastrophic damage to the fiber and perhaps the entire system. In contrast, our high power connectors feature an air-gap design, where the fiber extends into free space by 1.1 mm to 1.5 mm, providing an epoxy-free region where thermal energy is safely dissipated without burning the surrounding material.

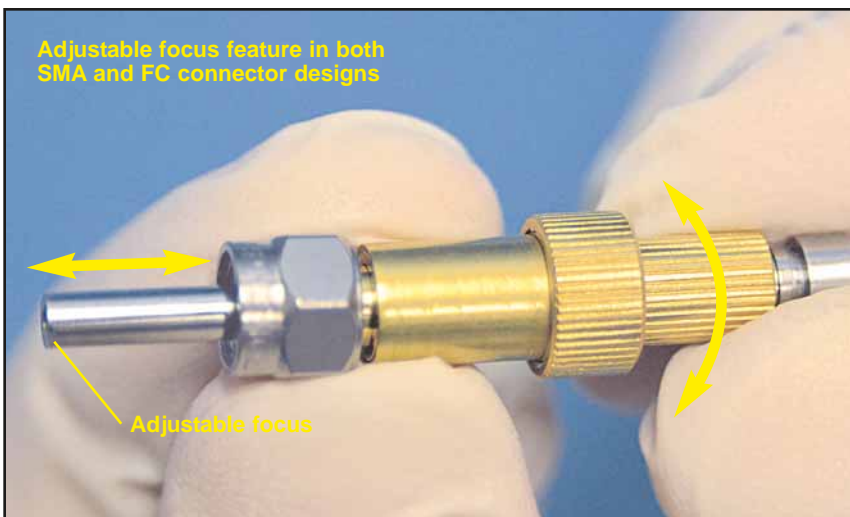

The fiber endface itself can be finished using several different techniques, depending on the maximum power requirements and cost restrictions. The simplest method is to polish the connector, as one does in standard connector termination (See figure 1B). While this provides a smooth finish, particles from the polishing material can embed themselves in the glass, forming absorption sites where the fiber can be burned. In addition, the fiber cladding has to exceed 200 microns to successfully polish the connector.

Power handling can be improved by mechanically cleaving the fiber instead, to give an optically smooth surface without polishing, thus preventing contamination (See figure 1C). Finally, the fiber can be laser treated to anneal the endface (See figure 1D). This technique gives the highest power handling possible. In all cases the fiber can be provided with either a flat or angled endface. PM fibers can also be angle cleaved but we cannot control the angle of the cleave with respect to the stress rods of the fiber.

Another way to improve power handling in certain applications is to fusion splice a short length of "coreless fiber" to the end of singlemode or polarization maintaining fiber (See figure 2). This is also known as a fiber endcap. This endcap allows the light to expand to about half the diameter of the endcap before it emerges from the glass into air, reducing the power density at the glass/air interface. For standard fibers this is typically 350 ± 25 microns long (OZ Optics can provide custom thickness endcaps). As it is this interface that is most sensitive to damage, expanding the beam increases the damage threshold. This method is only useful for fiber to free space applications, not fiber to fiber.

The end cap technique can also be used to terminate photonic crystal, or "holey" fibers. These fibers have a pattern of air holes in them, and these air holes constrain the light within the fiber. Potentially these holey fibers can give power handling that is several orders of magnitude better than conventional fibers. However, the air holes can trap dirt particles or other contaminants if left exposed on the fiber end. To prevent this, the end of the fiber can be capped with the coreless fiber, thus sealing the holes.

As an additional protective feature, the ends of mechanically cleaved fibers, laser treated fibers and fibers terminated with protective endcaps are recessed 15 ± 5 microns with respect to the front face of the protective metal ring. This feature, shown in figure 1, prevents accidental damage to the fiber endface and also reduces the likelihood of contamination from accidental contact. The recessed fiber feature also makes fiber to fiber butt-coupling possible. Normally if the fiber was flush with the connector ring, butt coupling would damage the fiber endface and thus dramatically lower the optical power handling capability. As an added surface, OZ Optics can AR coat the ends of the fiber, thus reducing reflections to minimize connector losses.

OZ Optics offers an adjustable focus feature in both SMA and FC connector designs to allow optimum coupling efficiency, which is critical in high power applications. A unique feature of the adjustable focus connector design is that one can adjust the distance the ferrule and fiber protrudes from the connector housing. An adjusting nut allows one to precisely position the fiber tip in free space, making it ideal for laser to fiber coupling. The connector also has a built-in residual spring mechanism that allows one to safely connect two fibers together. This spring cushion also allows the ferrule to make direct contact with a surface without damaging the fiber, thus providing additional safety. This patent pending design thus provides maximum precision with superb mechanical protection of the fiber. This makes it ideal for both free space and fiber to fiber applications.

In addition to patchcords, OZ Optics features high power laser to fiber delivery systems, optimized to work with our patchcords for maximum laser coupling. The high power adjustable SMA and FC connector designs are shown in Figs. 3 and 4 respectively. Our engineers have extensive working knowledge with both continuous output (CW) and pulsed laser applications, and can help you select the best system for your application. Contact OZ Optics for further assistance.

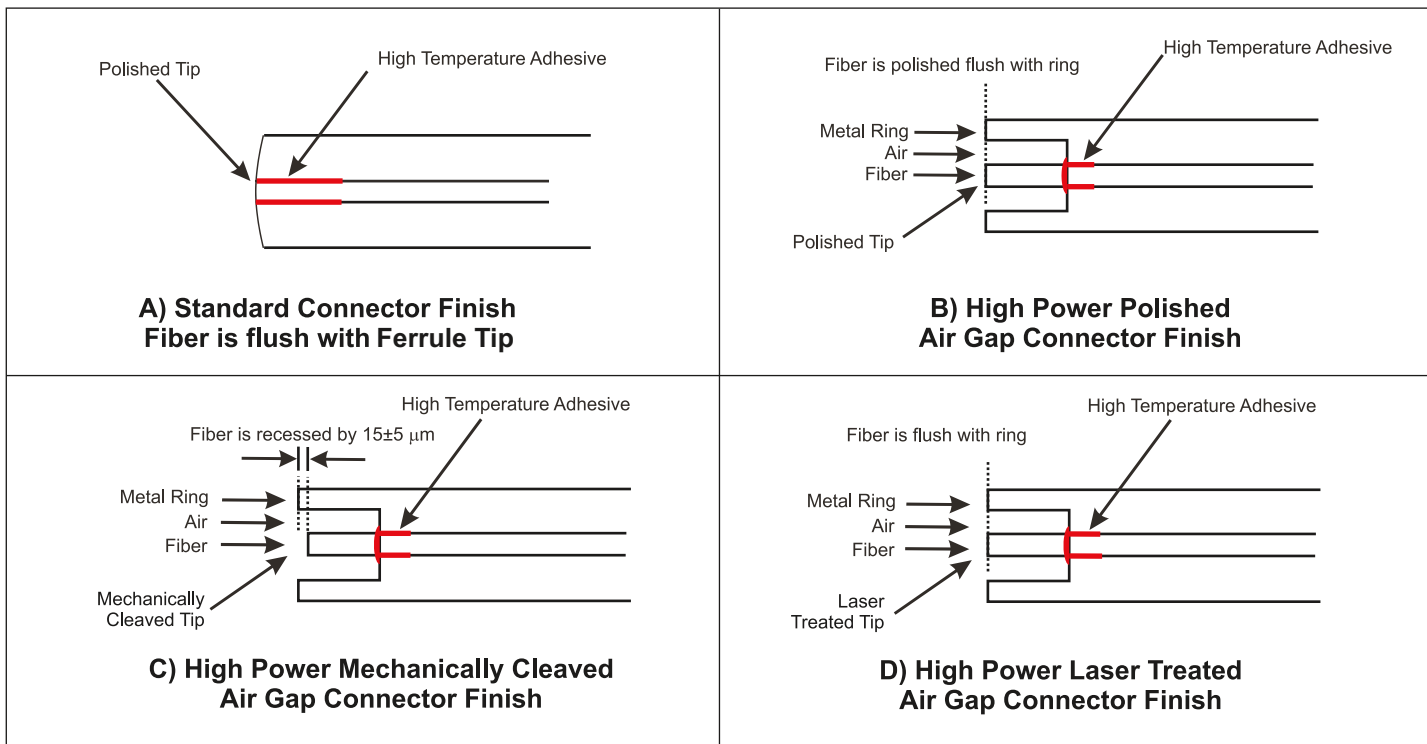

Figure 1: Possible Finishes For Standard And High Power Connectors

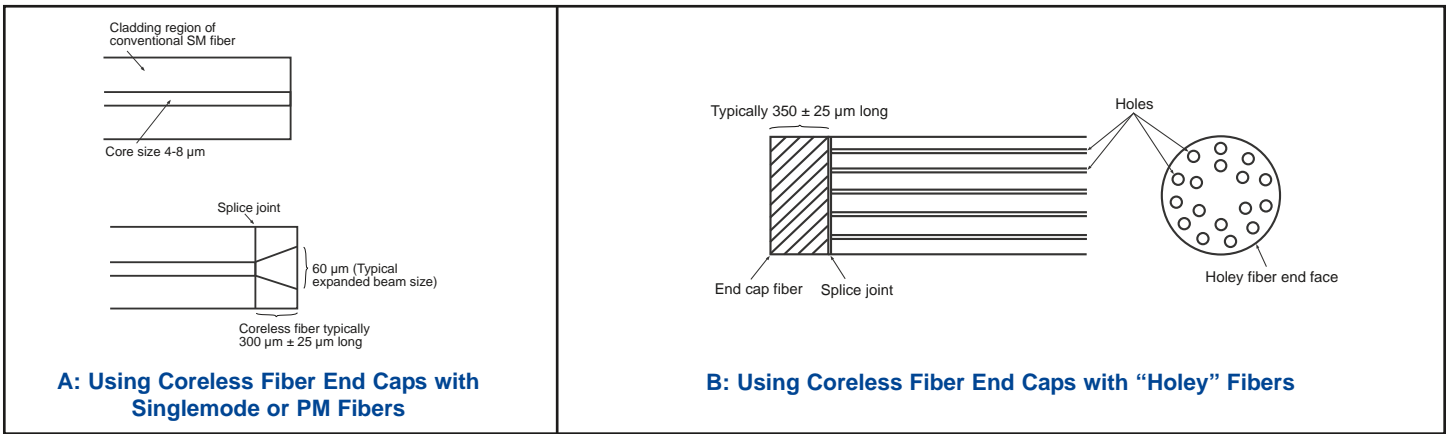

Figure 2: Use Of Coreless Fibers With Conventional And Photonic Crystal (Holey) Fibers

Table 1: Summary of Key Features of High Power Connectors

Item No.	Type of Connector Finish	Relevant Diagram	Key Feature(s)	Applicable Fiber Sizes	Connector Types Available (1)	Fiber Recess
1	Standard Finish	<p>A) Standard Connector Finish Fiber is flush with Ferrule Tip</p>	High Temp. Adhesive	All fiber sizes	FC, Adjustable FC, SMA 905 and Adjustable SMA 905	Fiber is polished flush with the ferrule tip
2	HP: High Power Polish	<p>B) High Power Polished Air Gap Connector Finish</p>	High Temp. Adhesive+ Air Gap Connector Design	From 200/240 μm to 940/1000 μm sized fibers, except Polymer clad fibers	FC, Adjustable FC, SMA 905 and Adjustable SMA 905	Fiber is polished flush with the metal ring
3	HPM: High Power Mechanical Cleave	<p>C) High Power Mechanically Cleave Air Gap Connector Finish</p>	Mechanical Cleave+High Temp. Adhesive+ Air Gap Connector Design	All fiber sizes and types except Polymer clad fibers and with the core to cladding diameter differential >60 microns	FC, Adjustable FC, SMA 905 and Adjustable SMA 905	Fiber is recessed by 15±5 microns from the metal ring edge
4	HPL: High Power Laser Treated	<p>D) High Power Laser Treated Air Gap Connector Finish</p>	Laser Treated+High Temp. Adhesive+ Air Gap Connector Design	For up to 200 μm core sized fibers (Laser Treated) except polymer clad fibers	FC, Adjustable FC, SMA 905 and Adjustable SMA 905	Fiber is polished flush with the metal ring
5	HPC: High Power Coreless Fiber Endcap	<p>E) High Power Coreless Fiber Endcap</p>	Mechanical Cleave+ Coreless fiber fusion splice +High Temp. Adhesive+ Air Gap Connector Design	All 125 μm and 250 μm OD cladding SM, PM, LMA fibers	Adjustable FC, and Adjustable SMA 905 only	Fiber is recessed by 15±5 microns from the metal ring edge

Notes:

(1): For more details see Table 2 on high power connector finishes available.

Adjustable focus instructions

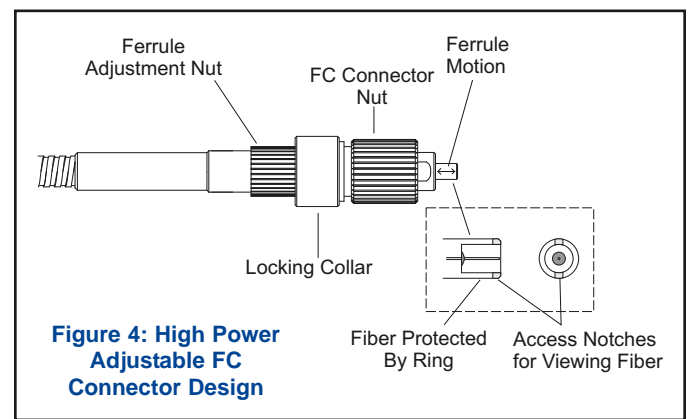
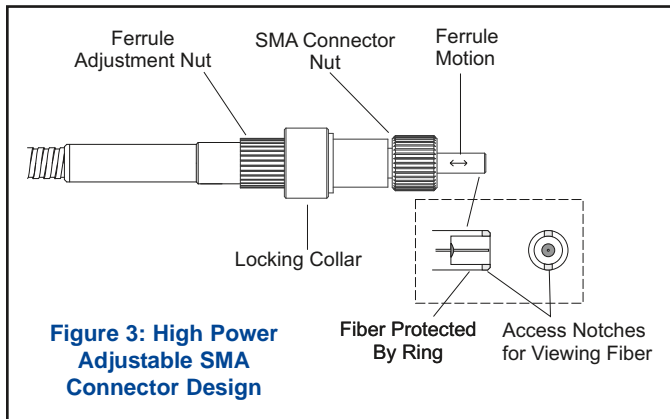
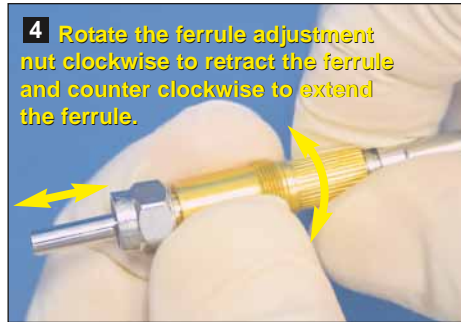

Lens Style High Power Fiber To Fiber Connectors

With standard connectors one can connect two fibers together by simply butting the connector ends together with a simple sleeve-through adaptor. This method cannot be used with air gap style connectors. Instead, OZ Optics offers a lens style fiber to fiber connector (See figure 5).

Lens style connectors consist of an input receptacle, a collimating lens, a focusing lens and the output receptacle. Light from the input fiber is first collimated, then focused back into the output fiber. The alignment is precisely controlled using OZ Optics' patented alignment technique. Lens style universal connectors are normally provided pre-aligned, but they are tilt adjustable. This enables one to compensate for any offsets between the fiber cores and the connector housings. In addition, because the fibers never make contact with another fiber or optic inside the device, the fiber endface cannot be damaged.

For minimum insertion losses, we recommend that you use the adjustable focus air gap connector designs with the lens style connectors. This allows one to compensate for any differences in the position of the fiber with respect to the guard ring, thus minimizing defocusing issues that can occur with non-adjustable airgap design connectors. Please refer to our data sheet titled *Universal Connectors and Hybrid Patchcords* for ordering information.

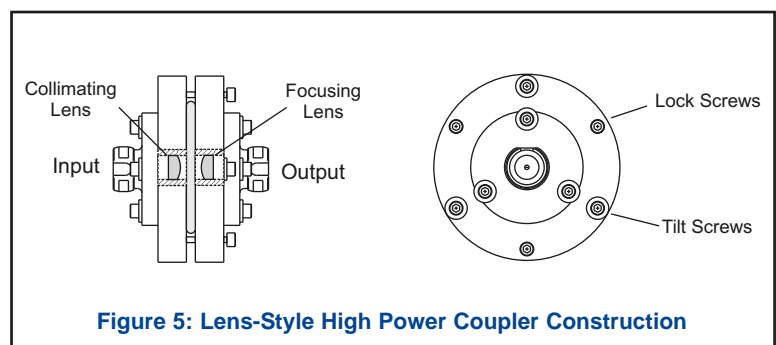

Ordering Information for Standard Parts:

OZ Optics manufactures patchcords specifically configured to meet customer requirements. As a result we offer a large selection of configurations. For reference, the following parts are examples of the patchcords OZ Optics has manufactured in the past.

Multimode Patchcords:

Bar Code	Part Number	Description
16974	QMMJ-5HP5HP-UVVIS-200/240-3AS-4	4 meter long, 3mm OD stainless steel armored cabled, 200/240 high powered multimode UVVIS fiber patchcord, terminated with high power air gap SMA 905 connectors on both ends.
14989	QMMJ-5HP5HP-IRVIS-940/1000-3AS-1	1 meter long, 3mm OD stainless steel armored cabled, 940/1000 high powered multimode IRVIS fiber patchcord, terminated with high power air gap SMA 905 connectors on both ends.
24654	QMMJ-5HP5HP-IRVIS-200/240-3AS-7	7 meter long, 3mm OD stainless steel armored cabled, 200/240 high powered multimode IRVIS fiber patchcord, terminated with high power mechanically cleaved air gap SMA 905 connectors on both ends.
17665	QMMJ-A3HP3S-UVVIS-25/125-3-2	2 meter long, 3mm OD PVC cabled, UVVIS 25/125 MM fiber patchcord, terminated with an adjustable high power air gap FC connector on one end and with a super FC/PC connector on the other end.

Singlemode Patchcords:

Bar Code	Part Number	Description
22611	QSMJ-A3HPM3S-320-2/125-3A-2	2 meter long, 3mm OD armored cabled, 2/125 singlemode fiber patchcord for 320nm, terminated with an adjustable high power mechanically cleaved air gap FC connector on one end and a Super FC/PC connector on the other end.
25483	QSMJ-A3HPMA3HPM-488-3.5/125-3AS-3	3 meter long, 3mm OD stainless steel armored cabled 3.5/125 singlemode fiber patchcord for 488nm, terminated with adjustable high power mechanically cleaved air gap FC connectors on both ends.
21213	SMJ-A3HPM3A-1060-6/125-1-3	3 meter long, 900µm OD jacketed 6/125 singlemode fiber patchcord for 1064nm, terminated with an adjustable high power mechanically cleaved air gap FC connector on one end and a Super FC/PC connector on the other end.

Polarization Maintaining Patchcords:

Bar Code	Part Number	Description
25008	QPMJ-A3HPM3S-488-3.5/125-3-5-1	5 meter long, 3mm OD Kevlar reinforced PVC cabled 3.5/125 PM fiber patchcord for 488nm, terminated with an adjustable high power mechanically cleaved air gap FC connector on one end, and a Super FC/PC connector on the other end.
25550	PMJ-A3HPMA3HPM-980-6/125-3AS-3-1	3 meter long, 3mm OD stainless steel armored cabled, 6/125 PM fiber patchcord for 980nm, terminated with adjustable high power mechanically cleaved air gap FC connectors on both ends.

Ordering Examples For Standard Parts:

A customer needs a high power patchcord to transmit 250 Watts of light with a 1064 nm wavelength. Reviewing table 5 of the Standard Tables shows that there is a fiber with a 940 micron core, 1000 micron cladding that can handle up to 650 Watts of power. Because the fiber is a large core multimode fiber he elects to use high power SMA connectors. The patchcord can be any length or cable type.

Bar Code	Part Number	Description
14989	QMMJ-5HP5HP-IRVIS-940/1000-3AS-1	1 meter long, 3mm OD stainless steel armored cabled, 940/1000 high powered multimode IRVIS fiber patchcord, terminated with high power air gap SMA 905 connectors on both ends.

Ordering Information For Custom Parts:

OZ Optics welcomes the opportunity to provide custom designed products to meet your application needs. Customized products do take additional effort, so please expect some differences in the pricing compared to our standard parts list. In particular, we will need additional time to prepare a comprehensive quotation, and lead times will be longer than for standard products. These points will be carefully explained in your quotation, so your decision will be as well-informed as possible.

Questionnaire For Custom Parts:

1. What wavelength of light will you be transmitting through the fiber?
2. Are you working with a pulsed or continuous source?
3. If continuous, what is the output power from your source, in Watts?
4. If pulsed, what are the pulse energies (in mJ), pulse duration (in nsec), and repetition rate?
5. Do you need multimode, singlemode, or polarization maintaining fiber?
6. If multimode, do you need graded index or step index fiber?
7. What fiber core/cladding size do you prefer?
8. What should the numerical aperture of the fiber be?
9. How long should the patchcord be, in meters?
10. What type of connectors do you need on each end?
11. What type of cabling do you need?

(-OPT)

Options:

- CF1 for cooling fins on the first end only
- CF2 for cooling fins on both ends
- CM1 for cladding mode stripping and cooling fins on the first end only
- CM2 for cladding mode stripping and cooling fins on both ends

Description

High Power Fiber Optic Patchcord

F = Fiber Type:

- QM = High power multimode fiber
- QS = High power singlemode fiber
- QP = High power polarization maintaining fiber

X,Y = Input and Output Connector Types:

Refer to table 2 below for high power connectors. For non-high power connectors, please refer to Table 6 of the *Standard Tables* data sheet.

http://www.ozoptics.com/ALLNEW_PDF/DTS0079.pdf

W = Wavelength in nm:

See tables 1 and 2 of the *Standard Tables* for standard singlemode and PM fiber operating wavelengths.

For multimode fibers specify either IRVIS for visible and infrared applications (400–2000nm), or UVVIS for ultraviolet and visible applications (200–700nm).

Part Number

FMJ - XY - W - a/b - JD - L-(A)(-OPT)

A = Alignment (Polarization maintaining patchcords only)

0 = unaligned and rotatable

1 = slow axis of the fiber aligned with respect to the key and locked

L = Patchcord length, in meters

JD = Jacket Diameter

3 = 3mm OD PVC loose tube with Kevlar

3A = 3mm OD armored

3AS = 3mm OD stainless steel armored

5A = 5mm OD armored

5AS = 5mm OD stainless steel armored

See table 7 of the *Standard Tables* for drawings

http://www.ozoptics.com/ALLNEW_PDF/DTS0079.pdf

a/b = Fiber core and cladding diameters, in microns: See tables 1 to 5 of the *Standard Tables* for standard fiber sizes.
http://www.ozoptics.com/ALLNEW_PDF/DTS0079.pdf

Table 2. High Power Connector Finishes Available

Connector Code	Description	Fiber Recessed
5HP	High power polished airgap SMA905 connector	NO
5HPM	High power mechanically cleaved airgap SMA905 connector	YES
5HPL	High power laser treated airgap SMA905 connector	NO
A5HP	Adjustable high power polished airgap SMA905 connector	NO
A5HPM	Adjustable high power mechanically cleaved airgap SMA905 connector	YES
A5HPL	Adjustable high power laser treated airgap SMA905 connector	NO
3HP	High power polished airgap FC connector	NO
3HPM	High power mechanically cleaved airgap FC connector	YES
3HPL	High power laser treated airgap FC connector	NO
3AHP	High power angle polished airgap FC connector	NO
3AHPM	High power mechanically angle cleaved airgap FC connector	YES
3AHPL	High power laser treated angle airgap FC connector	NO
A3HP	Adjustable high power polished airgap FC connector	NO
A3HPM	Adjustable high power mechanically cleaved airgap FC connector	YES
A3HPL	Adjustable high power laser treated airgap FC connector	NO
A3HPC	Adjustable high power end-capped mechanically cleaved airgap FC connector	YES
A3AHP	Adjustable high power angle polished airgap FC connector	NO
A3AHPM	Adjustable high power mechanically angle cleaved airgap FC connector	YES
A3AHPL	Adjustable high power laser treated angled airgap FC connector	NO
A3AHPC	Adjustable high power end-capped mechanically angle cleaved airgap FC connector	YES

Ordering Examples For Custom Parts:

A customer needs a high power patchcord to transmit 20 Watts of light at a 1064 nm wavelength. He requires the smallest available fiber with a numerical aperture of 0.22 or lower that will transmit this much power. Reviewing table 5 of the Standard Tables shows that there is a fiber with a 200 micron core, 240 micron cladding that can handle up to 30 Watts of power. Because the fiber is a large core multimode fiber he elects to use high power SMA connectors. The patchcord needs to be 5 meters long, with 3 mm diameter stainless steel armored cable for protection.

Part Number	Description
QMMJ-5HP5HP-IRVIS-200/240-3AS-5	5 meter long, 3mm OD stainless steel armored cabled 200/240 high power multimode IRVIS fiber patchcord, terminated with high power air gap SMA 905 connectors on both ends.

Frequently Asked Questions (FAQs):

- Q:** What are the maximum power handling levels for singlemode and polarization maintaining fibers?
A: It depends on the size of the fiber core and the operating wavelength. For instance singlemode fiber for 488nm can typically withstand a maximum of 1 to 3 Watts of continuous input power. In comparison 9/125 fiber can transmit 3 to 5 Watts of power. For fiber and wave lengths between these two examples the maximum power level will be somewhere between these two levels.
- Q:** I have a pulsed laser source. How do I select the correct fiber core size?
A: Pulsed lasers are more difficult to work with, because factors such as pulse energy duration and repetition rate must be factored into the calculation. We recommend contacting one of our sales representatives, who can determine the optimum fiber for your application.
- Q:** Can I connect together two fibers that are terminated with your high power connectors?
A: Our patented adjustable connector design allows one to safely connect two fibers together without damaging the fiber ends. A gap of between 20 microns and 100 micron in width will be present between the two fibers.
- Q:** What is the difference between a multimode fiber and a fiber bundle?
A: A multimode fiber is a single fiber, whose core is large enough to allow different paths, or modes, for the light to travel within the fiber core. In contrast a fiber bundle consists of several fibers glued together to form a bundle. Each fiber carries light independently. OZ Optics normally offers multimode fibers, not fiber bundles.
- Q:** Are there any special handling precautions when working with high power connectors and patchcords?
A: Yes. Two factors must be kept in mind at all times. First, the fibers must be aligned and tested at low powers and only once good coupling from the laser into the fiber is achieved can the input power be increased. Second, the fiber ends must be kept completely clean, as any contamination can cause burning of the fiber. See the application notes for further details.
- Q:** What sort of warranty do you provide?
A: OZ Optics products are warranted against defects in materials and workmanship for a period of 1 year, unless otherwise stated, from the date of delivery to the initial end-user of the product. However if a patchcord end gets burned during installation or operation at high powers, the failure is usually due to factors outside of our control, such as misalignment or contamination. As a result failures of this nature are usually not covered under warranty.

Application Notes:

Safe installation of high power patchcords in laser to fiber delivery systems:

Important: Before using OZ Optics' fibers with your equipment, make sure that you are familiar with all operating and safety instructions provided with your source. **OZ Optics is not liable for any damage or harm caused by misuse of either the laser or of OZ Optics devices.**

1. Before attaching the provided fibers to your system, inspect both the input and output connector ends. The endfaces should be clean, shiny, and as free from contamination as possible. If not, clean the ends as outlined in the section titled Maintenance. Check the fiber ends both before connecting the fiber and also after disconnecting the fiber. It is very easy for contaminants to be transferred from one connector to another if one is not careful.
2. To avoid damage to the fibers being used, turn the source off, or reduce the power level to less than 50mW before attaching the fiber. If any optics have to be aligned, then perform the initial alignment at low power (<50mW). Only after the optics are fully aligned and locked should the laser power be increased.
3. It is recommended that the laser power be increased by only 0.25 Watts every few minutes, and that the output power from the fiber should be monitored, to ensure that the coupling efficiency is not changing with power.
4. Do not use any index matching gel, thread locking fluid, or any lubricants with the connector. Do not use in the presence of chemical fumes or oils.

MAINTENANCE

When not in use, the ends of the fiber and the connector receptacles should be covered with the supplied metal caps. This will protect the connectors from dirt and contamination. **DO NOT USE PLASTIC CAPS.** Plastic caps often are contaminated with mold release agents, which can get onto the fiber ends. This contamination is extremely difficult to see, and resists cleaning.

Air gap connectors are best cleaned by immersing them in an ultrasonic bath containing either methanol (preferred) or isopropanol (acceptable). This thoroughly cleans the connectors without physically touching the fiber ends. Please read all safety instructions for both the cleaner and the solvents before using them. Use filtered compressed air to blow any dust or dirt off the ferrule when finished. Carefully inspect the tip of the fiber under reflected light. The tip should be clean and shiny.