

Distributor

 info@amstechnologies.com
 www.amstechnologies-webshop.com
Contact us

ITEM	Material	DESCRIPTION
1	LDA130	D-ZK3M MOLDED ASPHERE
2	3420015	SUS 304L HOUSING
3	3420001	SUS 304L FC/APC CONNECTORS

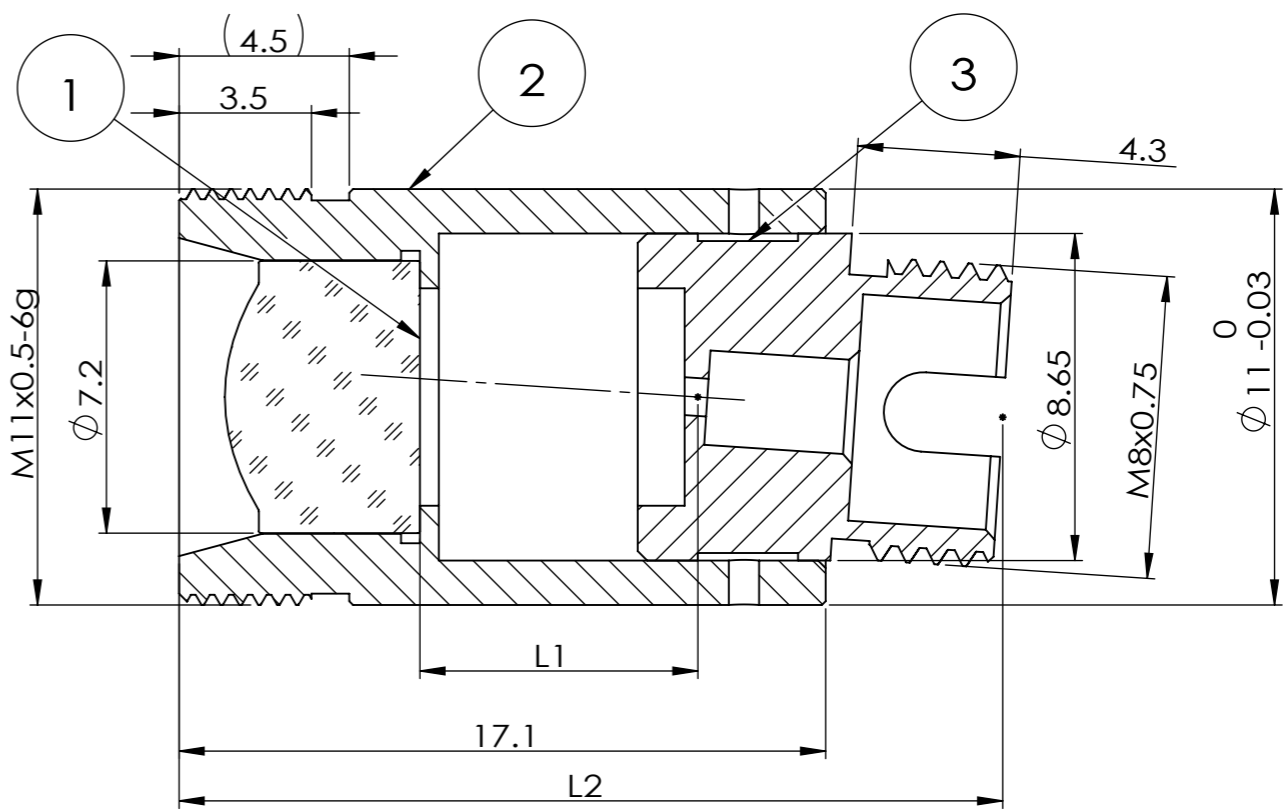
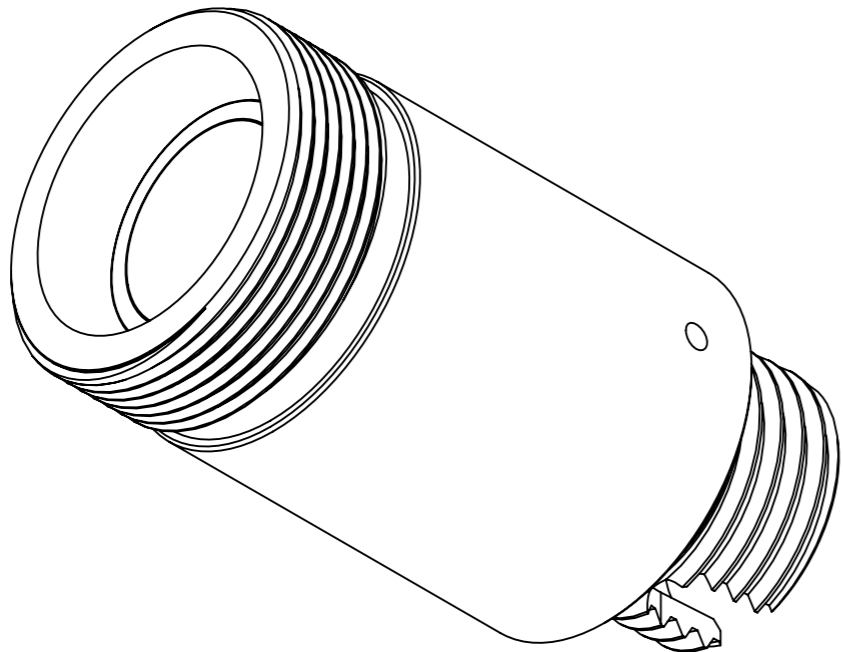

SECTION A-A

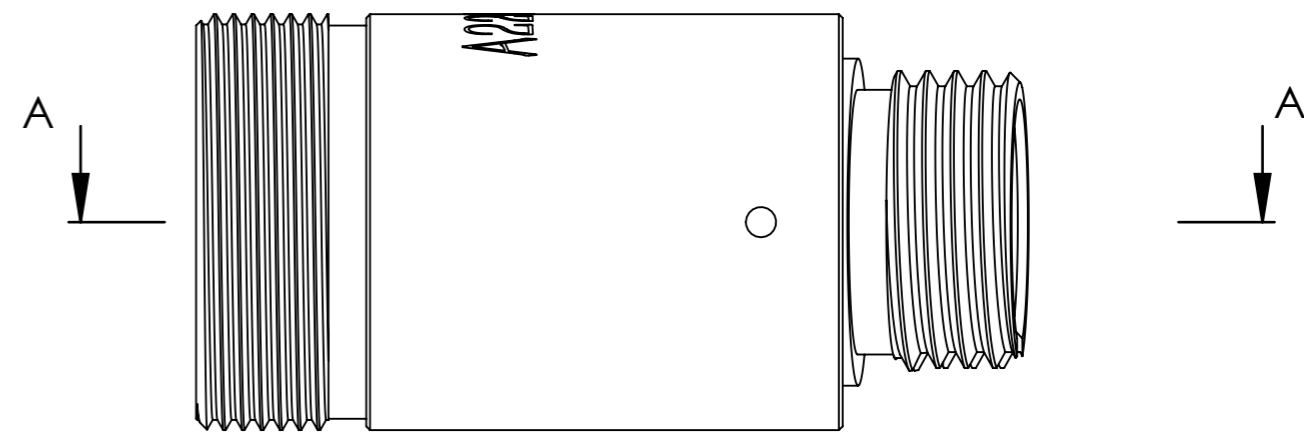

PART NUMBER	λ	ALIGNMENT FIBER	L1 (mm)	L2 ± 0.25 (mm)
FDA13010405	405nm	C405	7.53	22.21
FDA13010532	532nm	460HP	7.74	22.42
FDA13010633	633nm	SM600	7.82	22.50
FDA13010780	780nm	780HP	7.90	22.58
FDA13011064	1064nm	HI 1060	7.99	22.67
FDA13011310	1310nm	SMF-28e	8.05	22.73
FDA13011550	1550nm	SMF-28e	8.11	22.79

DO NOT SCALE DRAWING.

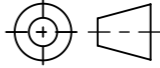
DRAWING PROJECTION. 

GH Optics (Jiangsu) Co., Ltd.
 www.ghoptics.cn

GHOPTICS
 光皓光学

TITLE:
 Connectorized Collimators with FC/APC

DWG NO.
FDA13010780

NAME	DATE
DRAWN	
CHK'D	
APPV'D	

UNIT: mm SIZE: A3 SHEET 1 OF 1 REV. A