

Lead Selenide Thermoelectrically Cooled Series G-G2-G21-GS21

FEATURES:

- Hermetically Sealed Packages
- Custom Wavelength Response
- Custom Test Procedure
- Custom Design Service
- 2 Year Warranty
- Customized Filters Available



HOW TO ORDER:

Select the proper electrical type: (G, G2, G21, GS21), and match it with the proper mechanical and package code number. Example: G-2-37, G2-1-5, G21-2-8. The active areas listed are considered standard sizes. Special sizes are available upon request. GS - Select High Performance PbSe - Contact NEP for availability.

NOTE: 3-6 Stage Thermoelectric Coolers and LN 2 Dewars available. Please contact NEP for further details.

Electrical Specifications			
Test Conditions at 25°C - Typical	G	G2	G21
D* (Pk., 1000,1) x 10 ¹⁰	.7	1.2	1.5
Wavelength Cut-off - Microns	5.2	5.3	5.4
Peak Wavelength Response - Microns	4.3	4.5	4.6
Time Constant - μSeconds	10	15	20
Resistance - Megohms	2-7	1-10	2-15
Operating Temperature - °C	-20	-30	-45
Cooler Power	1.0V/2A	0.8V/1.3A	2.1V/1.5A
Cooler Power - G5	2.0V/1.3A	N/A	N/A
Cooler Power - G10	3.9V/2.0A	N/A	N/A

Active Area Specifications

Code Number	Active Area		Bias Voltage Range		Typical VW-1 Responsivity			Package Size
	Inches	MM	Minimum	Maximum	-20	-30	-45	
1	0.040 x 0.040	1 x 1	1	100	9000	13000	16000	TO-5-37-8-66
2	0.080 x 0.080	2 x 2	1	200	-5000	8000	11000	TO-5-37-8-66
3	0.120 x 0.120	3 x 3	1	300	3000	5000	6500	TO-5-37-8-66
5	0.200 x 0.200	5 x 5	1	500	2000	3000	3500	TO-8-66
10	0.400 x 0.400	10 x 10	1	1000	1000	1500	1800	TO-3

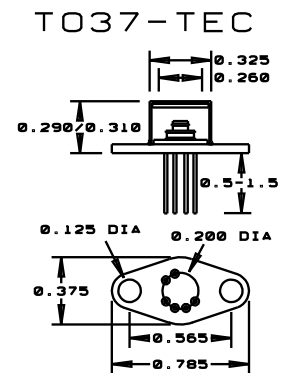
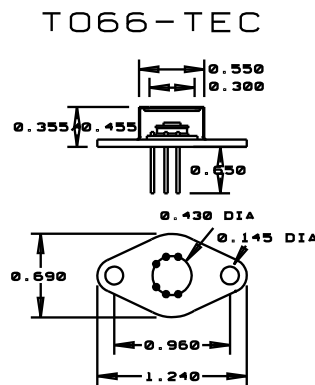
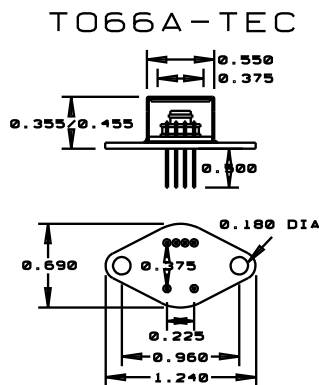
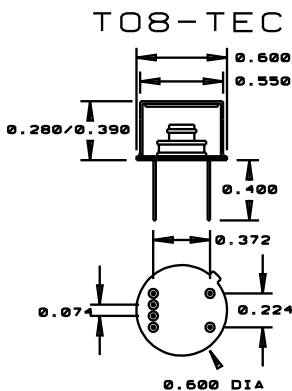

Distributor

where technologies meet solutions

info@amstechnologies.com
www.amstechnologies-webshop.com

Contact us

Ordering Information

Series Code	Description - Lead Sulfide (PbS)	Series Code	Description - Lead Sulfide (PbS)
A	Plate Cell	F	Plate Cell
B	Plate Cell	FA	Plate Cell, Medium Performance
C	Plate Cell	FS	Plate Cell, High Performance
AM	Type A, Hermetic Package	FM	Hermetic Package
BM	Type B, Hermetic Package	FAM	Hermetic Package, Medium Performance
CM	Type C, Hermetic Package	FSM	Hermetic Package, High Performance
D	1-stage TE cooled -20 C	G	1-stage TE cooled -20 C
D2	2-stage TE cooled -30 C	G2	2-stage TE cooled -30 C
D21	2-stage TE cooled - 45 C	G21	2-stage TE cooled -45 C

Size and Package Codes

Size Code	Description	Package Code	Description
25	.25 mm sq. - 0.010" SQ	5-46-8-66-37	TO-5, TO-46, TO-8, TO-66, TO-37, TO-3
50	.50 mm sq. - 0.020" SQ	5-46-8-66-37	TO-5, TO-46, TO-8, TO-66, TO-37, TO-3
1	1.0 mm sq. - 0.040" SQ	5-46-8-66-37	TO-5, TO-46, TO-8, TO-66, TO-37, TO-3
2	2.0 mm sq. - 0.080" SQ	5-8-66-37	TO-5, TO-8, TO-66, TO-37, TO-3
3	3.0 mm sq. - 0.120" SQ	5-8-66-37	TO-5, TO-8, TO-66, TO-37, TO-3
5	5.0 mm sq. - 0.200" SQ	8-66-3	TO-3, TO-8, TO-66
6	6.0 mm sq. - 0.240" SQ	3	TO-3
10	10.0 mm sq. - 0.400" SQ	3	TO-3

Other sizes and geometrics available. See Page 8 for Package Dimensions.

Liquid Nitrogen Dewars Available: D=Down Looking and S=Side Looking

Contact NEP or Visit our web site for more details

Examples

B-1	Lead Sulfide 1x1 mm plate cell
CM-5-8	Lead Sulfide 5x5 mm detector, in a TO-8 package, hermetically sealed
FM-3-5	Lead Selenide 3x3 mm detector, in a TO-5 package, hermetically sealed
D21-5-8	Lead Sulfide 5x5 mm detector with a 2-stage TE cooler, in a TO-8 package
NOTE:	TE cooled devices include thermistor: please add "C" for calibration
Arrays	Please contact NEP for array and multiplexed array orders

Response

Charts

PbSe
LEAD SULFIDE

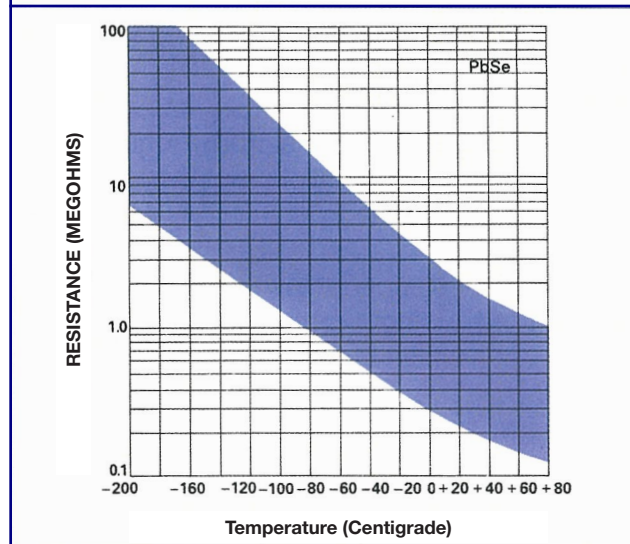
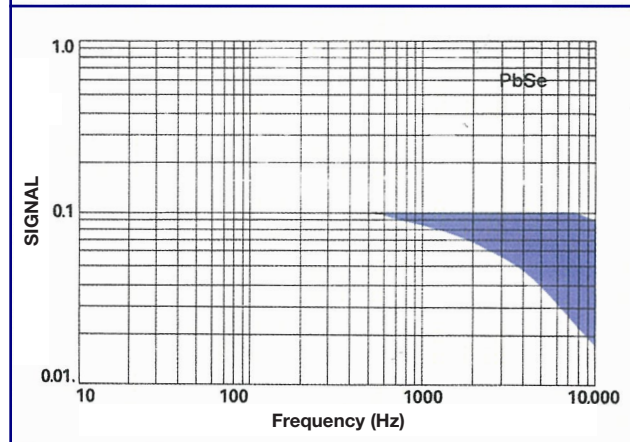
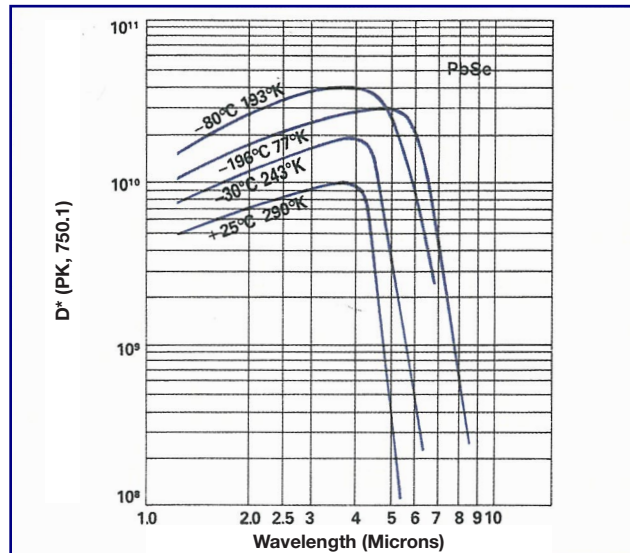

Detector Performance Terminology

Photoconductive Detector

A photon detector which exhibits increased conductivity with incident radiant power.

Photovoltaic Detector

A photon detector with a p-n or p-i-n junction which converts radiant power directly into electrical current; also called a photodiode.

D-Star (D^*)

A relative measure of sensitivity used to compare the detecting capabilities of different detectors. D^* is the signal-to-noise ratio at a specific electrical frequency with 1 Hz bandwidth when radiant power is incident on the detector active area.

Responsivity

A value indicating signal output from radiation incident on the detector element. The value where the detector has a maximum spectral response is called peak responsivity. It is a function of detector area, wavelength and circuit parameters.

Noise-Equivalent-Power (NEP)

The amount of required signal radiant power on the detector element area to yield a signal-to-noise ratio of one, and indicates the minimum detectable radiation level; the smaller the NEP value, the better the performance.

Resistivity

The square areas resistance of a thin film detector, where L and W are equal; L being the separation between the electrodes and W is the length of the detector area. Resistivity is a function of the detector element temperature and the level of irradiance.

RMS Signal Voltage or Current

The element of the electrical output (voltage or current) which is coherent with the monochromatic or blackbody input signal radiant power. It is a function of electrical frequency, signal power, spectral characteristics, operating temperature, and other circuit parameters such as the load resistor and bias voltage.

RMS Noise Voltage or Current

The element of the electrical output (voltage or current) which is incoherent with the signal radiant power, usually measured with no signal radiation incident on the detector element and is related to the detector area. It is the function of frequency response, noise equivalent bandwidth, operating temperature, other circuit parameters such as load resistor, and in some cases, detector solid angle and background temperature.

Dark Resistance

The ratio of the DC voltage across the detector to the DC current through it when no radiation is incident on the detector.

Dark Current

The measured current in a detector circuit when operated with no signal radiation incident on the detector element.

Bias Voltage

The voltage applied to the detector circuit, normally DC volts; sometimes called optimum bias for values which give optimum signal-to-noise ratios and maximum bias for values which product the maximum signal voltage output; it is called reverse bias when applied to the P-N junction of solid crystal detectors in a reverse mode to increase the speed of response or to increase the long wavelength response..

Background Temperature

The effective temperature of all radiation sources viewed by the detector, excluding the signal source.

Spectral Response

Most of the time, this is shown as D^* vs Wavelength; usually presented as a graph showing relative signal as a function of wavelength of the incident of radiant power.

Load Resistor

A resistance element that is in a series with the detector element and bias voltage; typically matched to the detector's dark resistance.

Open Circuit Voltage

A DC voltage produced by a photo voltaic detector when connected to a high impedance load.

Time Constant

A measurement of a detector's speed of response when the detector is exposed to a square-wave pulse of radiation. the rise time constant is the time required for the signal voltage to reach 0.63 times its asymptotic value. The decay time constant is the time required fr the signal voltage to decay to 0.37 of the asymptotic value. This can also be measured by determining the chopping frequency at which the signal response id 0.707 of its maximum value.

Rise Time - Fall Time

Rise time and fall time are the times in seconds required for the signal response to rise from 10% to 90% and fall from 90% to 10% of the maximum observed signal value. This happens when detectors are exposed to pulses of signal radiant power..

Cut-off Wavelength

The long wavelength point where the detector responsivity has degraded to a specific percent of the peak responsivity; usually 20% or 50% of the peak responsivity.

Distributor



amstechnologies
where technologies meet solutions

info@amstechnologies.com
www.amstechnologies-webshop.com

Contact us 