

LDT125-TO56WR 1300nm Edge-Emitting LED/TO56 Package

OSI Laser Diode, Inc.'s 1300nm edge-emitting LEDs (Light Emitting Diodes) feature stable power and spectral characteristics over temperature. These LEDs are typically used in data or analog transmission systems where the launch power requirements are too great for an SLED component and where a laser is not suitable. The ELED device is packaged in a 3 pin TO56 with window cap. This part is RoHS compliant.

Characteristics (T_{case} = 25° C.):

Parameter	Symbol	Conditions	Min.	Typ.	Max	Units
Optical power	P _o	I _f = 100mA; D/C = 100%	125			uW
Center wavelength	λ	I _f = 100mA; D/C = 100%	1265	1300	1330	nm
Spectral width (FWHM)	Δλ	I _f = 100mA; D/C = 100%		80		nm
Emitting area width	J _w	n/a		6		um
Emitting area height	J _h	n/a		2		um
Transverse FF Angle (50%)	θ _T	I _f = 100mA; D/C = 100%		85		deg
Lateral FF Angle (50%)	θ _L	I _f = 100mA; D/C = 100%		65		deg
Forward Voltage	V _{op}	I _f = 100mA; D/C = 100%		2		V
Optical Rise / Fall Time	T _{r/l}	I _f = 100mA; D/C = 100%		4		nS
Operating temp. range	T _{op}	I _f = 100mA; D/C = 100%	-40		85	°C
Storage temp. range	T _{stg}	Non operating	-55		85	°C

TO56 Package

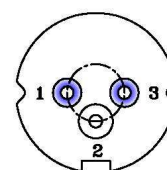
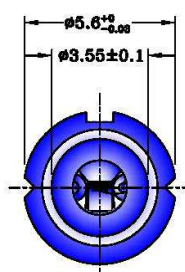
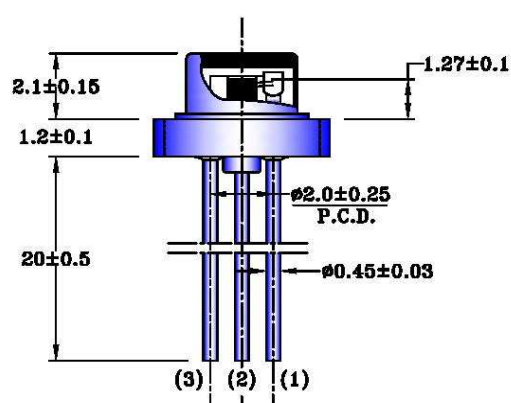

PIN ASSIGNMENT

PIN No.	FUNCTION
1	ELED CATHODE (-)
2	ELED ANODE (+)/GND
3	NO CONNECTION

Personal Hazard and Handling Precautions:
ESD precautions apply.

Warranty:
Please refer to your product purchase agreement for complete details or check with your OSI Laser Diode, Inc. sales representative.

Notice:
OSI Laser Diode, Inc. reserves the right to make changes to the products or information contained herein without notice. No liability is assumed as a result of their use or application.