

Distributor
 where technologies meet solutions
 info@amstechnologies.com
 www.amstechnologies-webshop.com
Contact us

ITEM	Material	DESCRIPTION
1	LDA520	D-ZK3M MOLDED ASPHERE
2	3420014	SUS 304L HOUSING
3	3420002	SUS 304L FC/PC CONNECTORS

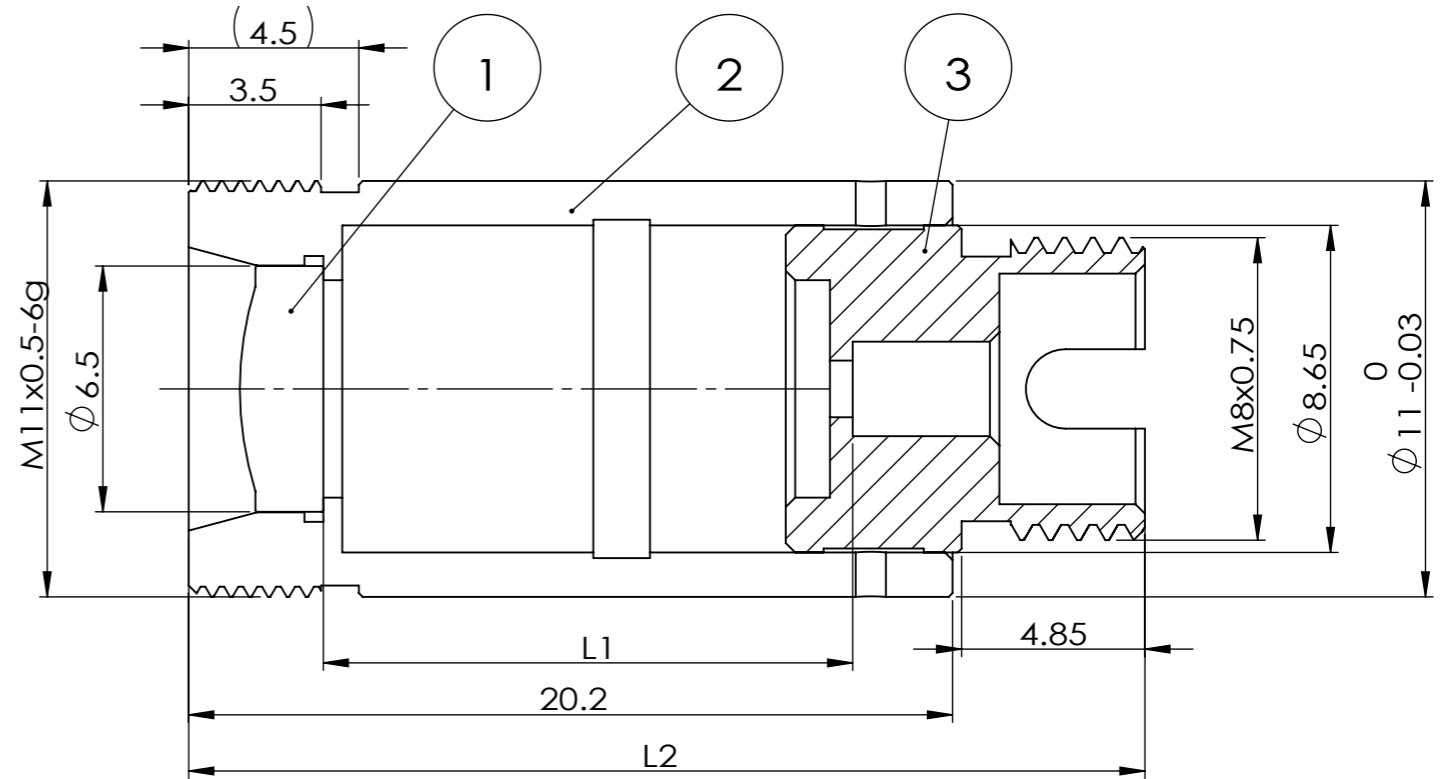

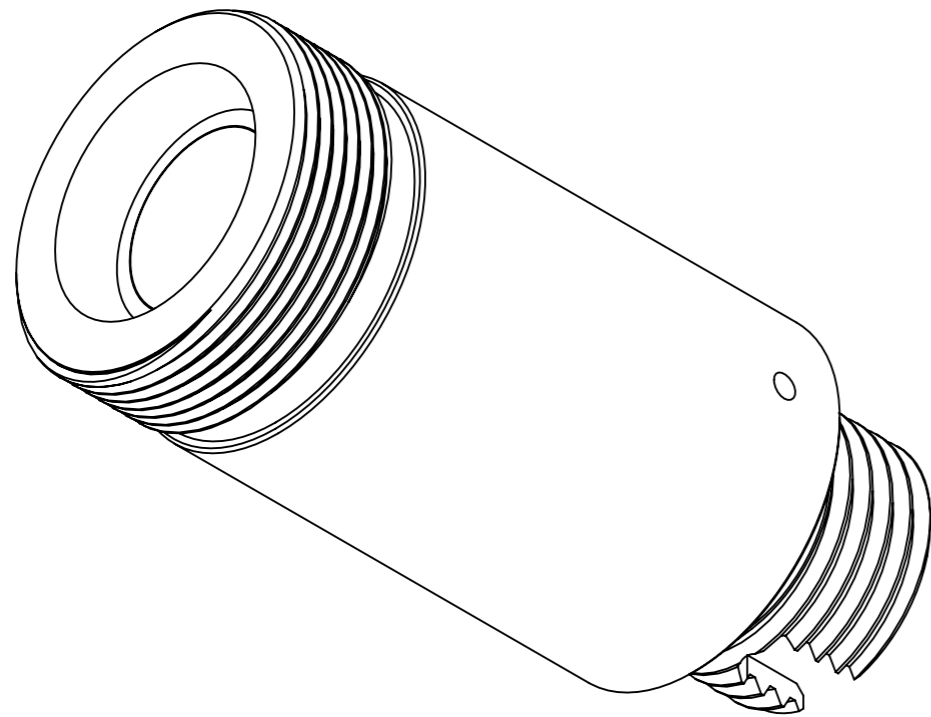
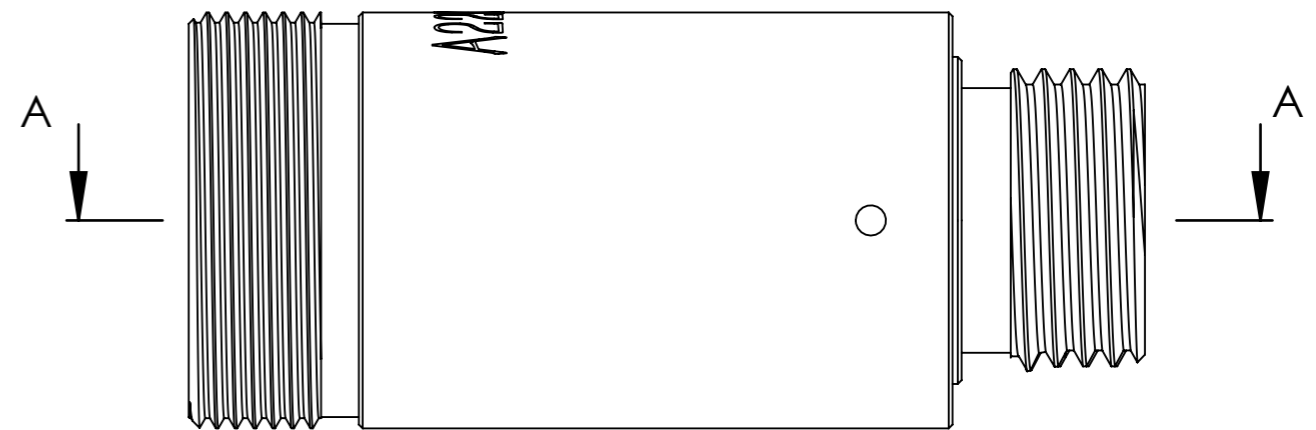

SECTION A-A

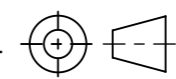

PART NUMBER	λ	ALIGNMENT FIBER	L1 (mm)	L2 ± 0.25 (mm)
FDA52020405	405nm	C405	13.33	24.72
FDA52020532	532nm	460HP	13.64	25.03
FDA52020633	633nm	SM600	13.77	25.16
FDA52020780	780nm	780HP	13.89	25.28
FDA52021064	1064nm	HI 1060	14.03	25.42
FDA52021310	1310nm	SMF-28e	14.12	25.51
FDA52021550	1550nm	SMF-28e	14.21	25.60

DO NOT SCALE DRAWING.

DRAWING PROJECTION. 

 **GH Optics (Jiangsu) Co., Ltd.**
www.ghoptics.cn

TITLE: Connectorized Collimators with FC/PC

DWG NO. **FDA52020780**

NAME	DATE
DRAWN	
CHK'D	
APPV'D	

UNIT: mm SIZE: A3 SHEET 1 OF 1 REV. A